



ELECTRIC WALL BOILER

Series ELEKTRA Compact.. BP

Silver Touch

Thank you for choosing an electric wall boiler FIAMMA, built with the most modern technologies, safe and tough materials, so as to ensure maximum efficiency of use, total quality of the device and extreme safety for user. The series **Elektra..** is built according to European standards dir. machines 2006/42 - IEC 60335-1:2010 EN 60335-1:2010 + AFH20F1:2010 + AFH20F1:2010. The obtained results can be summarized in the following key points:

- noiseless functioning, thanks to maximum insulation of the device by means of innovative special materials that ensures minimum heat loss.
- high degree of reliability, thanks to a careful choice of materials and to server tests carried out during production for each unit built.
- high performance with maximum efficiency, thanks to a modulation of electric power to the heating elements, according to the actual need of energy by the system or the need of sanitary water. The system D.E.S. manages the device with temperature probes positioned in each sensitive point of the boiler, so as to manage both comfort and economy functioning, in order to reduce power consumption when the device is not used at the maximum capacity or demand.
- the appliance is fully adjustable both in water temperature of the heating system (with the possibility to choice of system at high and low temperature for the underfloor systems) and in the domestic hot water temperature.
- The assembly of the components has been realized in order to allow an easy access to them, all from the front of the unit, for ordinary and extraordinary maintenance.

We recommend you to follow our instructions, and we suggest to contact the area authorized service FIAMMA in order to prepare a planned maintenance contract which can ensure suitable operation at maximum efficiency and safety, so that your machine use can go a long way. In renewing our thanks, our technical department and our sales network, are at your disposal for any further information.

FIAMMA GIRO s.r.l.
Company group



The company **FIAMMA GIRO s.r.l.** declines all responsibility for possible inaccuracies contained in this pamphlet, if due to printing errors or inadvertent errors. However, reserves the right to make changes to its products that it deems useful or necessary, without affecting the essential characteristics of the products manufactured and marketed.



WARNINGS:



THIS APPLIANCE MAY BE USED BY CHILDREN FROM 8 YEARS OF AGE AND OVER AND BY PERSONS WITH REDUCED PHYSICAL, SENSORY OR MENTAL CAPABILITIES OR LACK OF EXPERIENCE AND KNOWLEDGE, PROVIDED THAT THEY ARE SUPERVISED OR HAVE RECEIVED INSTRUCTIONS FOR THE SAFE USE OF THE APPLIANCE, SO THAT THEY UNDERSTAND THE RISKS INVOLVED. CHILDREN MUST NOT PLAY WITH THE APPLIANCE. CLEANING AND MAINTENANCE ACTIVITIES MUST NOT BE CARRIED OUT BY CHILDREN WITHOUT SUPERVISION.



THE CONNECTION TO THE ELECTRICITY NETWORK MUST BE THROUGH A DEVICE THAT ALLOWS ITS DISCONNECTION, WITH A CONTACT OPENING DISTANCE THAT ALLOWS COMPLETE DISCONNECTION UNDER THE CONDITIONS OF OVERVOLTAGE CATEGORY III, IN ACCORDANCE WITH THE INSTALLATION RULES.



IN ORDER TO PREVENT ANY RISKS, DAMAGED POWER SUPPLY CABLES MUST BE REPLACED BY THE MANUFACTURER OR ITS TECHNICAL SUPPORT SERVICE, OR BY SOMEONE WITH SIMILAR QUALIFICATIONS.



WATER MAY DRIP FROM THE OVERPRESSURE DRAIN PIPE OF THE APPLIANCE. FOR THIS REASON, SUCH PIPE MUST BE DIRECTED OUTSIDE AND LEFT OPEN.



THE PRESSURE RELIEF DEVICE MUST BE OPERATED REGULARLY TO REMOVE LIMESCALE DEPOSITS AND TO CHECK THAT IT IS NOT BLOCKED.



THE DRAIN PIPE CONNECTED TO THE OVERPRESSURE DEVICE MUST BE SET ON A CONTINUOUS DOWNWARD SLOPE AND IN A LOCATION PROTECTED FROM THE FORMATION OF ICE.



OVERALL DIMENSIONS

The **Elektra Compact.. BP** series is available in seven power versions, with same overall dimensions:

Elektra Compact 6 kW BP	6 kW maximum electric power
Elektra Compact 7 kW BP	7 kW maximum electric power
Elektra Compact 8 kW BP	8 kW maximum electric power
Elektra Compact 9 kW BP	9 kW maximum electric power
Elektra Compact 12 kW BP	12 kW maximum electric power
Elektra Compact 15 kW BP	15 kW maximum electric power
Elektra Compact 18 kW BP	18 kW maximum electric power

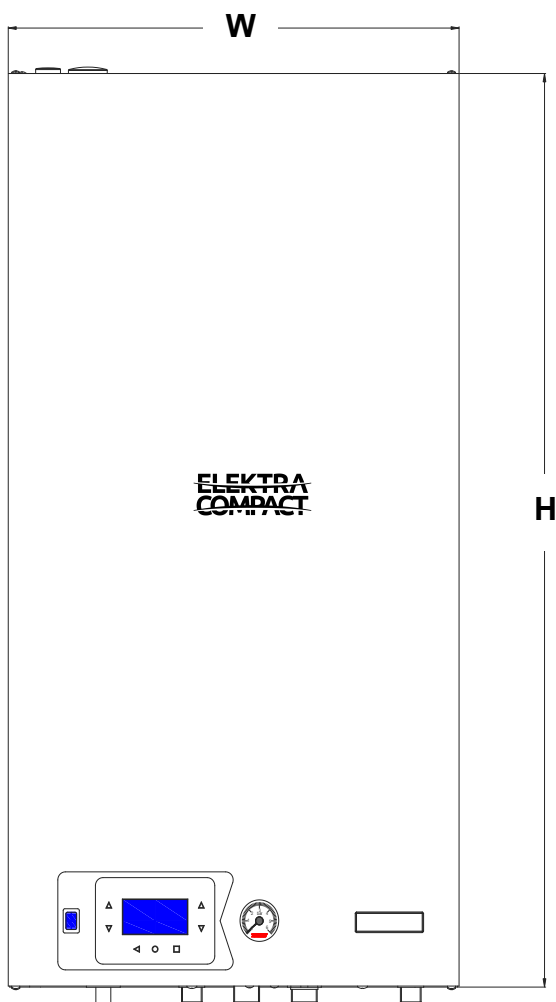

Appliance:

W (Width):	453 mm
H (Height):	875 mm
D (Depth):	428 mm
Weight:	58 kg

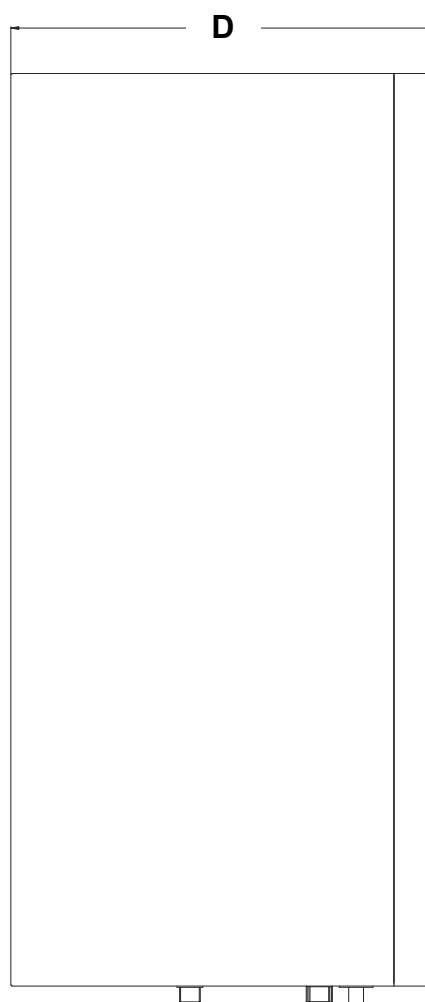

Packing dimensions:

Width:	500 mm
Height:	940 mm
Depth:	520 mm
Weight:	61 kg



HYDRAULIC CONNECTIONS - Connection arrangement diagram:

M	Central Heating Delivery:	$\frac{3}{4}$ " M
R	Central Heating Return:	$\frac{3}{4}$ " M
AF	Sanitary Cold Water:	$\frac{1}{2}$ " M
AC	Sanitary Hot Water:	$\frac{1}{2}$ " M
VSR	Central Heating Safety Valve (0.3 MPa - 3 bar):	$\frac{1}{2}$ " F
VSS	Sanitary Water Safety Valve (0.65 MPa - 6.5 bar):	$\frac{1}{2}$ " F

The appliance is designed to be continuously connected to the water mains without intermediate fittings.

View from below (under the boiler)

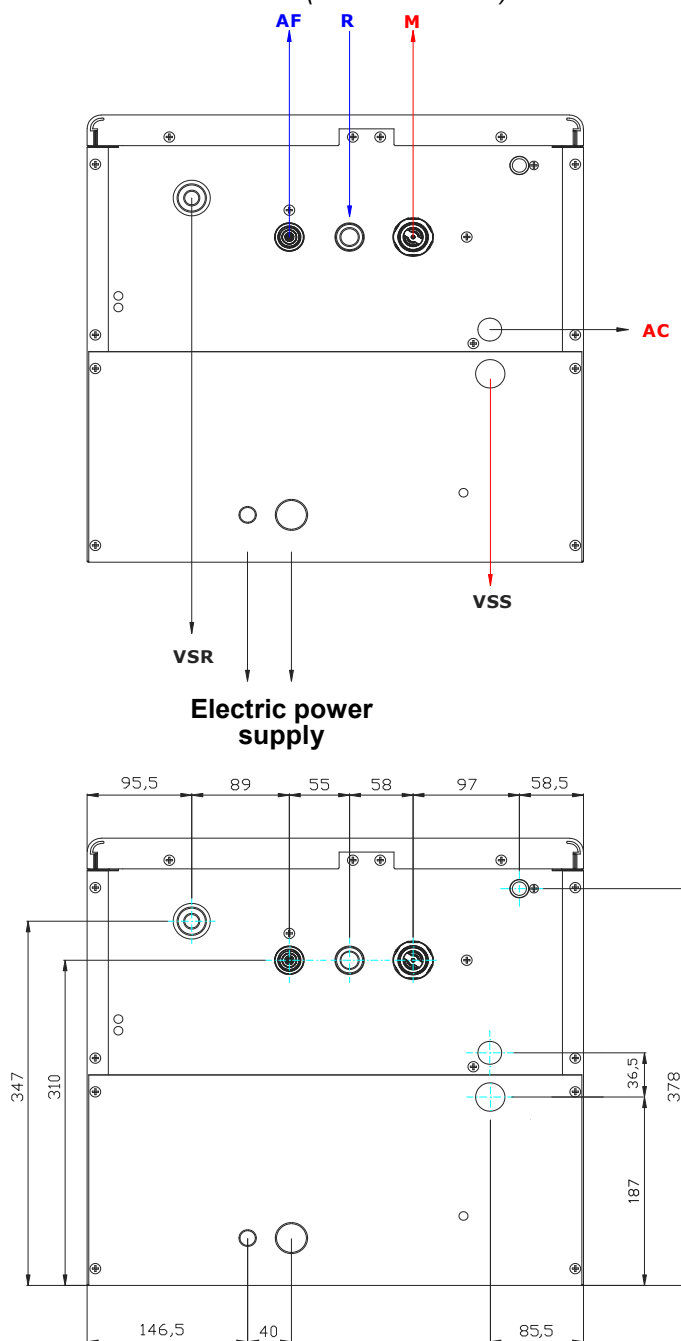



MAIN TECHNICAL FEATURES

Elektra Compact 6 kW BP 6 kW maximum electric power

Single-phase power supply: 230-240 V - 50 Hz

Weight: 58 kg.

37 litres storage tank in vitrified steel with inspection flange and magnesium anode.

Central heating system: 6 kW electric/thermal power from no.2 heating elements (no.2 of 3x1 kW).

Sanitary hot water: 2 kW (2,000 W) electric heating element for the sanitary hot water tank.

Maximum head available to the circulator approx 7 m.

Expansion vessel capacity 9 litres.

0.3 MPa (3 bar) central heating circuit safety valve.

0.65 MPa (6.5 bar) sanitary water circuit safety valve.

Maximum central heating operating pressure: 0.25 MPa (2.5 bar).

Maximum sanitary water operating pressure: 0.55 MPa (5.5 bar).

Minimum central heating circuit operating pressure: 0.06 MPa (0.6 bar).

Minimum sanitary water operating pressure in "*comfort*" mode: 0.025 MPa (0.25 bar).

Minimum sanitary water operating pressure in "*economy*" mode: 0.005 MPa (0.05 bar).

Central heating circuit-boiler body maximum thermal safety limit: 100°C.

Elektra Compact 7-8-9 kW BP 7-8-9 kW maximum electric power

Single-phase power supply: 230-240 V - 50 Hz

Weight: 58 kg.

37 litres storage tank in vitrified steel with inspection flange and magnesium anode.

Central heating system: 7-8-9 kW electric/thermal power from no.2 heating elements (no.1 of 3x2 kW and no.1 of 3x1 kW).

Sanitary hot water: 2 kW (2,000 W) electric heating element for the sanitary hot water tank.

Maximum head available to the circulator approx 7 m.

Expansion vessel capacity 9 litres.

0.3 MPa (3 bar) central heating circuit safety valve.

0.65 MPa (6.5 bar) sanitary water circuit safety valve.

Maximum central heating operating pressure: 0.25 MPa (2.5 bar).

Maximum sanitary water operating pressure: 0.55 MPa (5.5 bar).

Minimum central heating circuit operating pressure: 0.06 MPa (0.6 bar).

Minimum sanitary water operating pressure in "*comfort*" mode: 0.025 MPa (0.25 bar).

Minimum sanitary water operating pressure in "*economy*" mode: 0.005 MPa (0.05 bar).

Central heating circuit-boiler body maximum thermal safety limit: 100°C.



MAIN TECHNICAL FEATURES

Elektra Compact 12 kW BP 12 kW maximum electric power

Single-phase power supply: 230-240 V - 50 Hz

Weight: 59 kg.

37 litres storage tank in vitrified steel with inspection flange and magnesium anode.

Central heating system: 12 kW electric/thermal power from no.2 heating elements (no.2 of 3x2 kW).

Sanitary hot water: 2 kW (2,000 W) electric heating element for the sanitary hot water tank.

Maximum head available to the circulator approx 7 m.

Expansion vessel capacity 9 litres.

0.3 MPa (3 bar) central heating circuit safety valve.

0.65 MPa (6.5 bar) sanitary water circuit safety valve.

Maximum central heating operating pressure: 0.25 MPa (2.5 bar).

Maximum sanitary water operating pressure: 0.55 MPa (5.5 bar).

Minimum central heating circuit operating pressure: 0.06 MPa (0.6 bar).

Minimum sanitary water operating pressure in "comfort" mode: 0.025 MPa (0.25 bar).

Minimum sanitary water operating pressure in "economy" mode: 0.005 MPa (0.05 bar).

Central heating circuit-boiler body maximum thermal safety limit: 100°C.

Elektra Compact 15 kW BP 15 kW maximum electric power

Single-phase power supply: 230-240 V - 50 Hz

Weight: 60 kg.

37 litres storage tank in vitrified steel with inspection flange and magnesium anode.

Central heating system: 15 kW electric/thermal power from no.3 heating elements (no.2 of 3x2 kW and no.1 of 3x1 kW).

Sanitary hot water: 2 kW (2,000 W) electric heating element for the sanitary hot water tank.

Maximum head available to the circulator approx 7 m.

Expansion vessel capacity 9 litres.

0.3 MPa (3 bar) central heating circuit safety valve.

0.65 MPa (6.5 bar) sanitary water circuit safety valve.

Maximum central heating operating pressure: 0.25 MPa (2.5 bar).

Maximum sanitary water operating pressure: 0.55 MPa (5.5 bar).

Minimum central heating circuit operating pressure: 0.06 MPa (0.6 bar).

Minimum sanitary water operating pressure in "comfort" mode: 0.025 MPa (0.25 bar).

Minimum sanitary water operating pressure in "economy" mode: 0.005 MPa (0.05 bar).

Central heating circuit-boiler body maximum thermal safety limit: 100°C.



Elektra Compact 18 kW BP 18 kW maximum electric power

Single-phase power supply: 230-240 V - 50 Hz

Weight: 60 kg.

37 litres storage tank in vitrified steel with inspection flange and magnesium anode.

Central heating system: 18 kW electric/thermal power from no.3 heating elements (no.3 of 3x2 kW).

Sanitary hot water: 2 kW (2,000 W) electric heating element for the sanitary hot water tank.

Maximum head available to the circulator approx 7 m.

Expansion vessel capacity 9 litres.

0.3 MPa (3 bar) central heating circuit safety valve.

0.65 MPa (6.5 bar) sanitary water circuit safety valve.

Maximum central heating operating pressure: 0.25 MPa (2.5 bar).

Maximum sanitary water operating pressure: 0.55 MPa (5.5 bar).

Minimum central heating circuit operating pressure: 0.06 MPa (0.6 bar).

Minimum sanitary water operating pressure in "comfort" mode: 0.025 MPa (0.25 bar).

Minimum sanitary water operating pressure in "economy" mode: 0.005 MPa (0.05 bar).

Central heating circuit-boiler body maximum thermal safety limit: 100°C.

POSITIONING OF THE BOILER

The appliance must always be installed on a vertical solid wall capable of supporting its weight, using the support bracket included in the packaging.

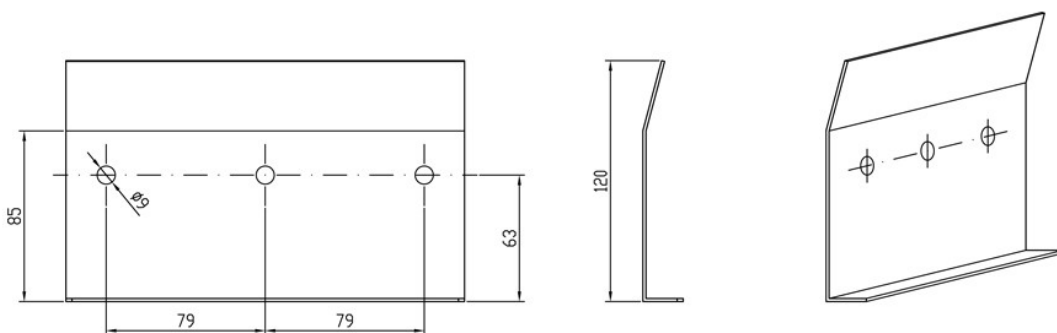

The bracket must be secured to the wall by means of three M8 screws with appropriate plugs for the type of wall (not supplied with the boiler).

The appliance must be attached to the top of the bracket, inserting the bent section of the same through the boiler frame at the back.



CONTROL PANEL

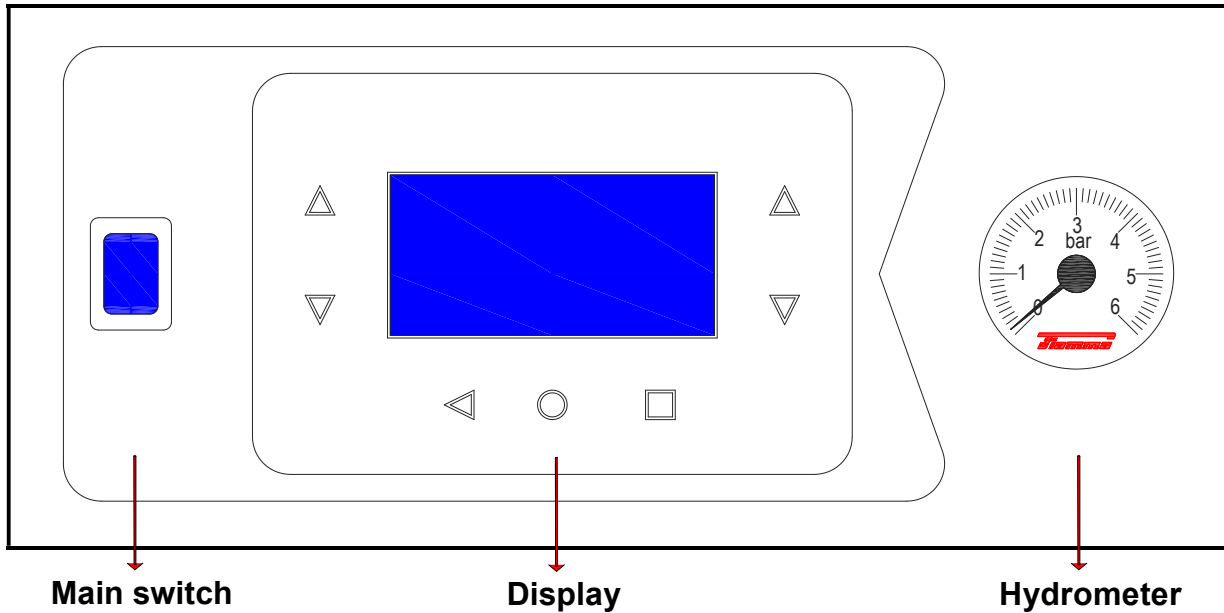

The control panel, consisting of the display screen, the function selection keys, the illuminated main switch and the hydrometer, can be found at the bottom left of the front of the appliance (see image above).

Keypad (control panel)

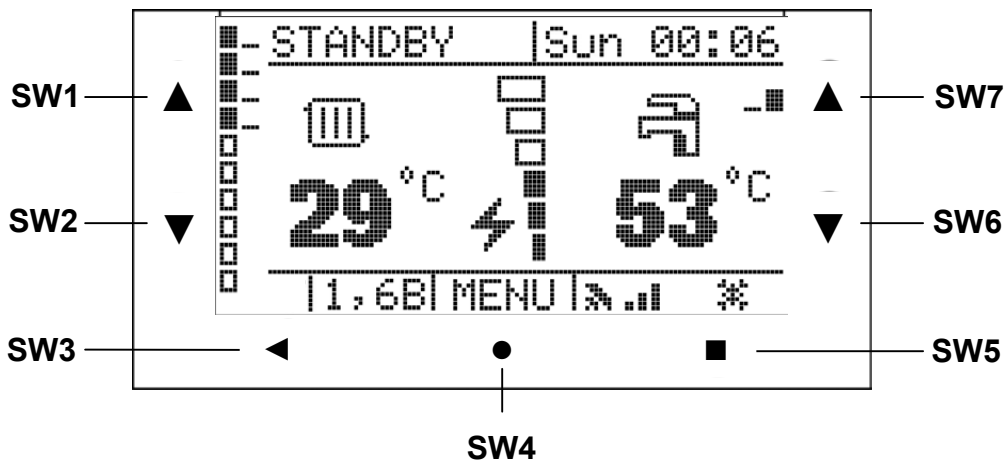

Key	Function
▲ left (sw1)	Display / Increase of the central heating system setpoint (or room temperature)
▼ left (sw2)	Display / Decrease of the central heating system setpoint (or room temperature)
◀ (sw3)	Safety thermostat error reset / back function
● (sw4)	Menu
■ (sw5)	ON/OFF switch - Summer – Winter "Comfort" function activation (extended pressure)
▼ right (sw6)	Display / Decrease of the water heater setpoint
▲ right (sw7)	Display / Increase of the water heater setpoint



Description of main screen keys:

▲ (SW1): Can be used to increase the central heating system temperature setpoint; the status bar shows "CH Set. ", and both the temperature setpoint value and the  icon will flash for 5 seconds.

▼ (SW2): Can be used to decrease the central heating system temperature setpoint; the status bar shows "CH Set. " and both the temperature setpoint value and the  icon will flash for 5 seconds.

If the board is set to manage two separate zones, at the end of the 5 seconds the status bar shows "CH Set. 2 ", at which moment it is possible to set the heating setpoint for the secondary system.



If operation with external probe (SE) is set on the board, using the " idx: 006 val:001 " parameter the ▲ (SW1) and ▼ (SW2) keys will allow to increase and decrease the room setpoint; the status bar shows " Room Set. " and both the temperature setpoint value and the  icon will flash for 5 seconds.

◀ (SW3): If the boiler has locked, press this button to attempt to release it.

WARNING: the locking function is a software function. Release can be attempted for a maximum of 5 times during a period of 15 minutes.

● (SW4): Can be used to access the " SETTINGS MENU ".

■ (SW5): Can be used to change the operating mode of the boiler: OFF, SUMMER, WINTER.

Press this key for more than 5 seconds to activate "comfort" mode: next to the  icon, the display will also show the  icon.

▼ (SW6): Can be used to decrease the sanitary hot water temperature setpoint; the status bar shows "DHW Set. " and both the temperature setpoint value and the  icon will flash for 5 seconds.

▲ (SW7): Can be used to increase the sanitary hot water temperature setpoint; the status bar shows "DHW Set. " and both the temperature setpoint value and the  icon will flash for 5 seconds.

The sanitary hot water (DHW) temperature can be changed regardless of the operating mode, winter or summer.



Heating system water pressure reading

The analogue hydrometer on the control panel has a bar dial from 0 to 6 bar. The current central heating system water pressure is indicated by the black needle. The optimum central heating system water pressure is between 1 and 1.5 bar. The pressure can exceed 1.5 bar, to a maximum of 2 bar (maximum expansion of the system during a temperature rise). Pressures over 2 bar are not within the operating range of the appliance. When this level is exceeded, the action of the pressure transducer will cause the display of the "ERROR F 10" error message and the boiler will remain in operation. However, if the threshold of 2.8 bar is exceeded, the system stops until the pressure falls back within the allowed range. The minimum operating pressure is 0.8 bar (+/-0.2 bar). If the pressure detected by the transducer is less than 0.7 bar, the "ERROR F 1" message appears and the operation of the system stops. The last safety feature of the boiler is the mechanical valve, which when a pressure of 3 bar is reached starts to release water through the **VSR** drain, the position of which can be found in the hydraulic connection diagram (see page 6).

SWITCHING ON THE BOILER

The boiler is switched on by pressing the luminous main switch found on the left of the display in the dashboard. If the boiler is connected to a single-phase power supply source, the button lights up when pressed (230-240 V - 50 Hz). After the short graphic presentation, set the day and time (if required) and choose summer/winter operating mode using the ■ (**SW5**) key at the bottom right (pressing again will switch off the boiler, while keeping it powered).

MAIN SCREEN

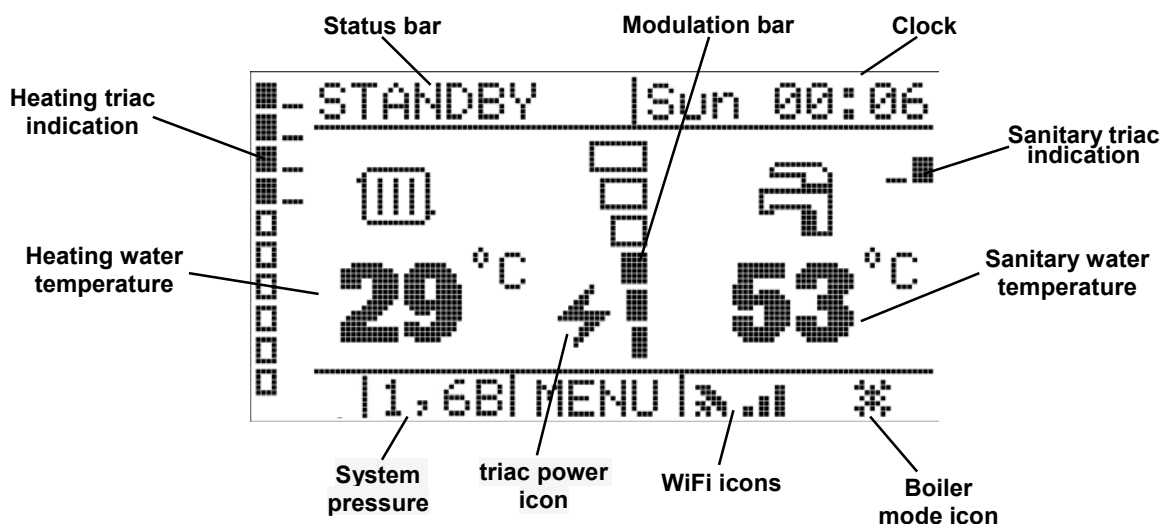







The status bar at the top shows the operating status of the boiler or, in case of fault, the fault code.



The table below shows all the possible status bar messages:

STATUS / DISPLAY	DESCRIPTION
STANDBY	No heat request received by the boiler
ANTI-FREEZE STATUS	Anti-freeze active
COMFORT MODE	"Comfort" mode active
HEATING STATUS	Heating active
ANTI-LEGI ONELLA	Anti-legionella active
SANITARY WATER STATUS	Sanitary water active
OFF	Boiler OFF
TEST STATUS	Test active
CH set.	Central heating setpoint
CH set. 2	Central heating setpoint zone 2
DHW Set.	Sanitary hot water setpoint
Room Set.	Room setpoint
ERROR F X	Presence of fault or lock X
Communication error	No communication between the display and the boiler board NOTE: In the fault log, the communication error is assigned code 250
DEGAS. TIME XX:XX	"Degassing" function active and time to completion

During "STANDBY", the top right of the status bar shows the day of the week and the time.

The value below the radiator icon  is the temperature detected by the central heating system delivery probe, while below the tap icon  is the temperature detected by the sanitary hot water system probe. The  and  icons flash in case of central heating system or sanitary hot water request..

If management with external SE probe is enabled (parameter menu "idx: 001 val: 001"), it is also possible to set the room temperature setpoint.

The screen will show the  symbol instead of the  symbol, and the room temperature setpoint instead of the central heating system delivery temperature. At the centre is a graduated bar that shows the operating power of the boiler. In case of heating request, the  icon appears at the side of the bar.



The rectangles on the left of the screen show the status of the triacs powering the central heating system heating elements (full rectangle for active triacs and empty rectangle for triacs that are not powered). The lines next to the rectangles show the power output on each triac: 1 power line 1/2 kW, 2 power lines 3/4 kW and 3 power lines 6 kW.

	Active Triac operating a heating element with 6 kW power
	Active Triac operating a heating element with 3 or 4 kW power
	Active Triac operating a heating element with 1 or 2 kW power
	Triac not active

The right side of the screen shows the triac that powers the heating element of the sanitary hot water system. If active, the rectangle is full, otherwise it's empty. The small rectangles on the side show the power output (in this case only one of 2 kW).

On the bottom left is the value of the system pressure detected by the pressure transducer and on the bottom right the current boiler operating mode (❄ winter mode, ☀ summer mode).

SYMBOL	MODE	DESCRIPTION
	OFF	Central heating and sanitary hot water functions off.
	SUMMER	Central heating function off. Sanitary hot water function on.
	WINTER	Central heating and sanitary hot water functions on.

If "SUMMER" mode is selected in the main screen, the temperature detected by the delivery probe disappears and is replaced with the sun icon (see screen below).

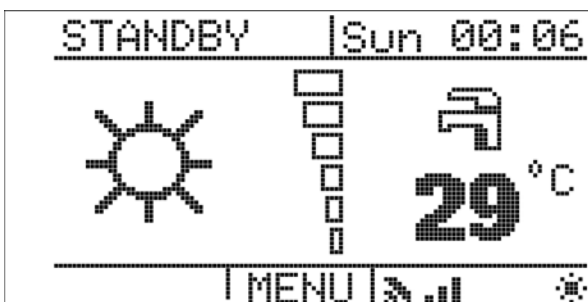



If "OFF" mode is selected, the display shows the following:

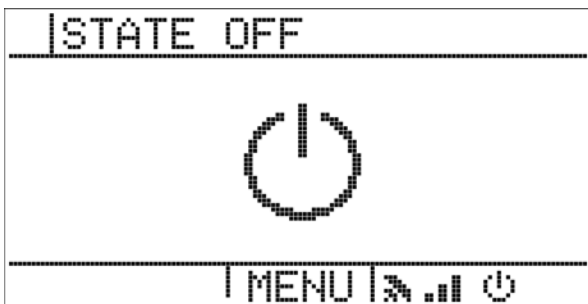

If the boiler is connected to a WiFi network, the following icons appear: . The graduated bar indicates the quality of the WiFi signal (3 bars very good, 2 bars medium, 1 bar poor). In the event of WiFi network or internet communication fault, these icons may start flashing or disappear. A detailed indication of the type of WiFi fault can be found under the "Info" item in the "WiFi Menu" discussed in the appropriate paragraph.

SETTINGS MENU

From the main screen, press ● (SW4) to access the " SETTINGS MENU ". The screen displayed will be as follows:

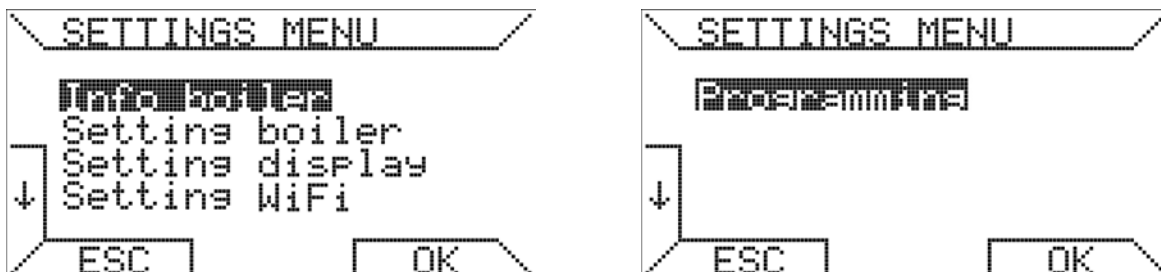

The keys take on different functions depending on the actual screen displayed. The frame at the edge of the screen allows to indicate which function the corresponding button is used for. Taking the above screen as an example, press ▼ (SW2) [↓] to select "Setting boiler", or ◀ (SW3) [ESC] to return to the main screen, or ■ (SW5) [OK] to access the "Info Boiler" menu.



The table below describes the hierarchical system of the "SETTINGS MENU":

SETTINGS MENU	Info boiler	
	Setting boiler	Installer menu
		Factory menu
		Device menu
		Faults history
		Degasser
		Boiler SW version
		Special functions
	Setting Display	Language
		Time setting
		Contrast
		Brightness
		Touch sensitivity
		Factory reset
		Data monitor
	Setting WiFi	Conn. method
		Server rate
		Start wizard
		Info WiFi
		WiFi monitor
		Password App
		Download certs
	Programing	Set program
		Day Copy
		Show program
		Temperature
		Set thermostat

Info boiler

Select "Info boiler" in the "SETTINGS MENU" to view information regarding the devices connected to the boiler:

```

INFO BOILER 1
CH Temp.    : 31 °C
DHW Temp.   : 29 °C
Extern T.   : -2 °C
↓ Th. Room  : N.A.
ESC
  
```



The table below summarizes all the possible devices that can be displayed in the "Info boiler", their description, and the values that they can assume:

INFO BOILER	INFORMATION	DESCRIPTION / VALUES
1	CH Temp	Temperatures detected by the delivery probe (SM)
	DHW Temp.	Temperature detected by the sanitary hot water tank probe (SB)
	External T.	Temperature detected by the external probe (SE)
	Th. Room	Room thermostat (TA) status: ON: Closed OFF: Open
2	Th. Safety	Safety thermostat (TS) status: ON: Closed OFF: Open
	OpenTherm	OpenTherm communication status: ON: Active OFF: Not active
	RS 485	RS485 communication status (cascade): ON: Active OFF: Not active
	Press.H2O	Water pressure switch status (if present): ON: Closed OFF: Open If transducer present: PRESSURE TRANSDUCER VALUE
3	Flow H2O	Sanitary water system flow meter value
	Circulator	% System circulator speed
	Diverter valve	Diverter valve status: ON: Active OFF: Not active
6	Th. Room2	Secondary zone room thermostat status: ON: Closed OFF: Open
	CH Temp2	Temperatures detected by the secondary zone probe
7	Circ feedb	
	PUMP Zone 1	Primary zone pump status: ON: Active OFF: Not active
	POMP Zone 2	Secondary zone pump status: ON: Active OFF: Not active
	Mix closing	Mixing valve closing status: ON: Active OFF: Not active
8	Mix Opening	Mixing valve opening status: ON: Active OFF: Not active



INFO BOILER	INFORMATION	DESCRIPTION / VALUES
3	Gate 1	Power in kW of triac number 1
4	Gate 2	Power in kW of triac number 2
	Gate 3	Power in kW of triac number 3
	Gate 4	Power in kW of triac number 4
	Gate 5	Power in kW of triac number 5
5	Gate 6	Power in kW of triac number 6
	Gate 7	Power in kW of triac number 7
	Gate 8	Power in kW of triac number 8
	Gate 9	Power in kW of triac number 9
6	Gate 10	Power in kW of triac number 10
	Gate S	Power in kW of triac S (sanitary hot water triac)
N.A: "N.A" on the side of the device indicates that the device is not active or not installed in the system.		

Setting boiler

The second item "Setting boiler" of the "SETTINGS MENU" can be used to view and modify the boiler and central heating system setting parameters. The parameters and their meanings are described in detail in the relevant paragraph.

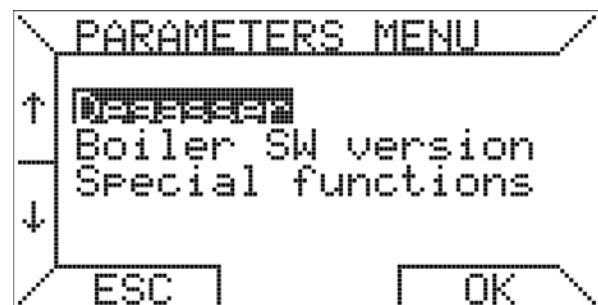

The menus for setting the boiler and heating system parameters have been sorted into sub-menus according to the type of setting and access right.

The "Installer menu" only contains the essential parameters for the configuration of the boiler type.



When accessed, this menu shows the "Read parameter" screen:



where the parameter index is shown on the left and its current value on the right. The value does not appear instantaneously but is transferred each time from the control board of the boiler. Before its appearance, three dashes will be displayed for a few

moments "---". Press ▼ (SW6) [↓] and ▲ (SW7) [↑] to scroll through the entire list of parameters. Press ■ (SW5) [SET] to access the parameter edit screen. Finally, press ◀ (SW3) [ESC] to return to the "PARAMETERS MENU".

In the "Write parameter" screen, the index is blocked and the value is highlighted.

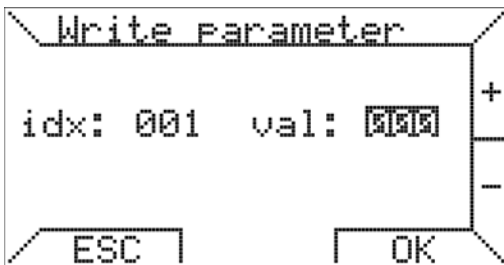

Press ▼ (SW6) [-] and ▲ (SW7) [+] to change the parameter value, followed by ■ (SW5) [OK] to save the new value. Press ◀ (SW3) [ESC] to return to the "Read parameter" screen without changing the parameter.

Access to the other sections of the "PARAMETERS MENU" ("Factory menu", "Device menu") is password protected, meaning that the correct password must be entered in the password screen.

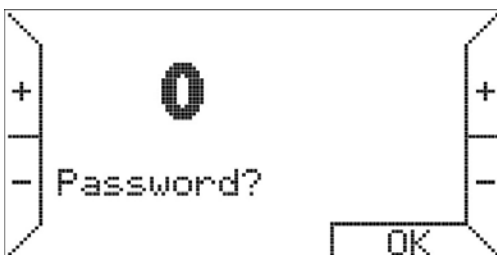

Accessing "Faults history" allows to view the list of the faults occurred in the boiler. If there are no faults, the following screen is displayed

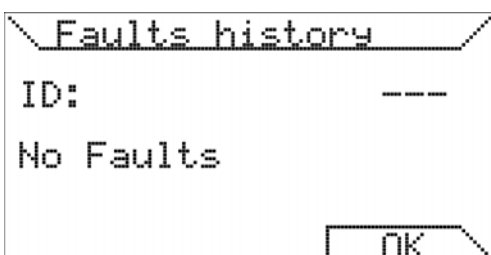



In case of fault or lockout, the above screen is updated as follows:



Where:

ID: Index ID of the fault occurred.

Fault F: fault or lockout code.

Faults are indexed in succession starting with " **ID:** 001 ". Each time there is a new fault the previous ones are moved upwards, up to a maximum of 10. After that, every time there is a new fault the oldest one is deleted.

Press ▲ (SW7) [+] and ▼ (SW6) [-] to scroll through the faults occurred.

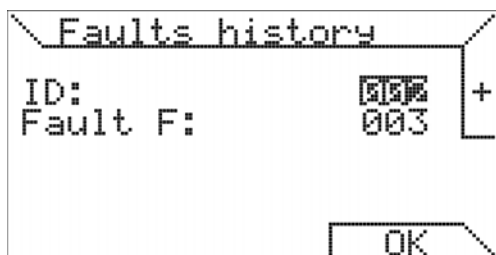

The " **De-gasser** " option allows to activate the boiler circulator, to remove air residues from the system. Also in this case, ▼ (SW6) [-], ▲ (SW7) [+] and ■ (SW5) [OK] can be used to activate or deactivate the function.

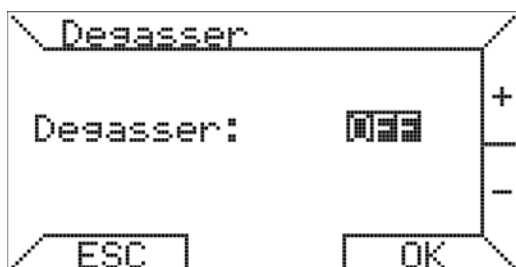

During this function, the PWM circulator maximum and minimum speed operating statuses are alternated, in order to facilitate the escape of air bubbles from the hydraulic circuit. The sequence is illustrated below.

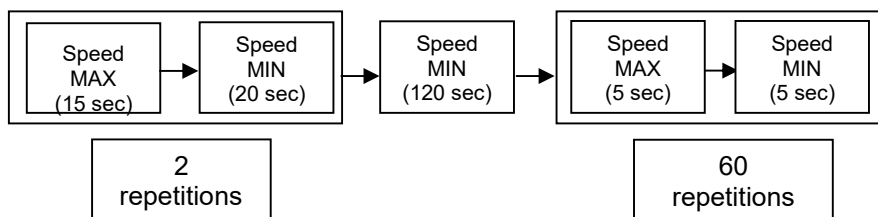

When this function is active, a timer appears on the display to indicate the time required to complete the function.



Under "Boiler version", it is possible to view the version of the software loaded on the boiler control board.



The last item, "Special functions", is password protected and is used to activate the boiler demo mode. During demo mode, fictitious information is shown on the display so that, for example, it is possible to simulate running with triacs activated, without them actually being powered.

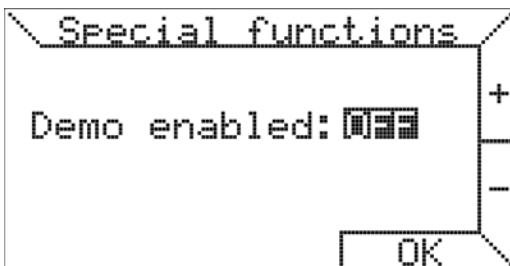

Setting display

The third item of the "SETTINGS MENU" can be used to change the display settings. In the first screen, it is possible to change language, time, contrast and brightness. In the second screen, it is possible to change the touch sensitivity, perform a factory reset and monitor the serial communication between the display and the board of the boiler.

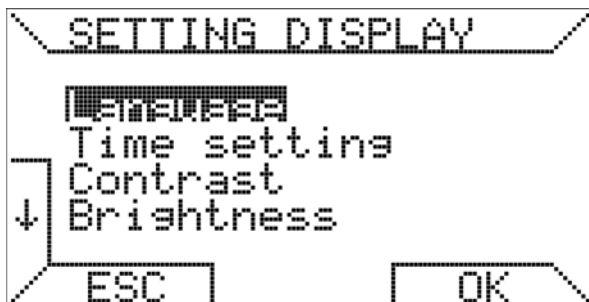



In the " **Brightness** " option, it is possible to set the maximum intensity and also the minimum idle intensity, which activates when the display remains inactive for one minute.

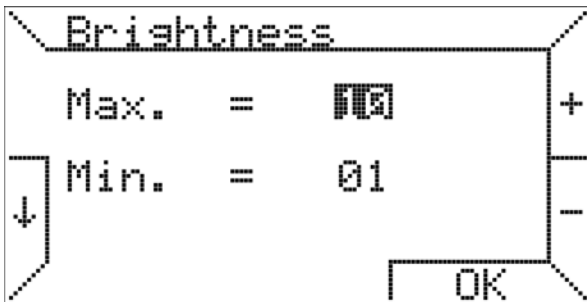

The parameters set in the " **Setting Display** " menu are stored in the memory and are preserved in case of power failure. To restore the factory default values, simply go to " **Factory reset** " and press ■ (SW5) [OK].

After a reset, the language selection menu will appear on the display.



The " **Data monitor** " option allows to check the communication between the display and the board of the boiler. The following screen appears:

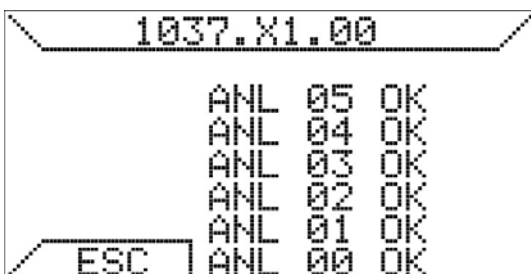

in which the status of the exchanged data is shown next to the index on each line. If the data has been exchanged correctly, " **OK** " will appear; errors will be indicated with the " **ERR** " message. If no data exchange is detected, the " **TIME** " message will

appear. The top of the screen also shows the software revision of the display.



Setting WiFi

The WiFi menu can be used to manage the WiFi connectivity settings. In specific, it is possible to complete the network connection procedure, set the data transfer rate (Server rate), display the MAC address of the WiFi module and the IP address assigned by the network. The first time it is accessed, the "Setting WiFi" screen looks as shown below:

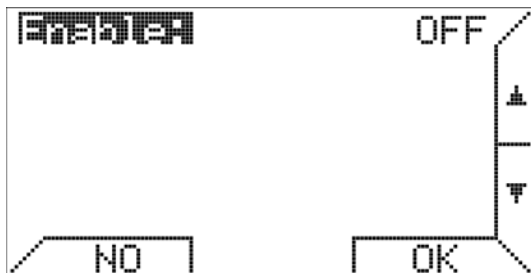

Touch the ■ (SW5) [OK] key and the ▼ (SW6) [↓], ▲ (SW7) [↑] keys, followed by ■ (SW5) [OK] again to activate the WiFi connection. The following additional items will be added to the screen:

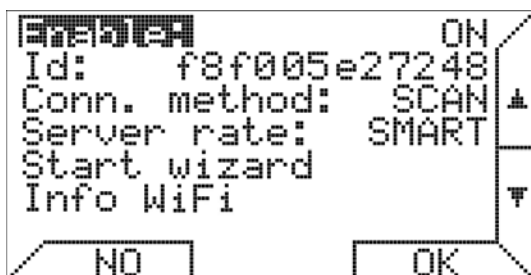

The second row shows the "Id" address of the WiFi module installed on the boiler. The third row is used to select the method for connecting to the network. The available choices are "SCAN" and "PROV" (provision).

If "SCAN" is selected, after launching the connection procedure with the fourth item "Start wizard", a network selection screen will appear, followed by a screen for entering the network password.

The "PROV" method requires a smartphone to perform the procedure. The steps are as follows:

- 1) Select the fourth item "Start wizard" so that the boiler can generate a local network under the name "CHRONO WIFI". The display will show "WAITING CREDENTIALS".
- 2) In your smartphone, go to the WiFi network settings menu and select the "CHRONO WIFI" network created by the boiler, entering the network password **1234567890**.



- 3) Your smartphone will open a web page in your browser where you can select the network (SSID) to which you want to connect the boiler. If the web page does not open automatically, open your smartphone browser and enter **www.chronowifi.com**.

The screenshot shows a mobile web interface titled "Connect to Network". It is divided into two main sections. The top section contains three input fields: "Network Name", "Pass phrase", and "Device Name", each with a blue button labeled "Connect" below it. The bottom section is titled "Detect Device" and contains a blue button labeled "Refresh".

- 4) Touch the "Refresh" button in the "**Detect device**" section to update the networks detected by your smartphone.
- 5) When you select the network in the "**Detect Device**" section, it will appear in the "**Network Name**" window.
- 6) Enter the password in the "**Pass phrase**" box. Enter a name of your choice in the "**Device Name**" box. Touch "**Connect**" button to initiate the connection.
- 7) The display screen of the boiler will show " CREDENTIALS OK ". Touch ■ (SW5) [OK] on the display and wait for the connection to the WiFi network to be established.

Continuing with the WiFi setting procedure, in " Server rate " it is possible to select the data transfer speed between the boiler and the smartphone.

The possible alternatives are " MIN " (minimum), " NORM " (normal), " SMART " (smart), " MAX " (maximum). " MAX " will ensure very fast transfer speed, but will also result in higher consumption.

The fifth item " info WiFi " shows further information regarding the WiFi communication status. In particular:

STATUS: the network status (connection enabled STATUS=1 otherwise STATUS=0).

SSID: the name of the connected network.

IP: the IP address assigned by the DHCP server to the boiler.

SIGNAL: the signal strength detected by the boiler.



PING: the time required to transfer data from the boiler to the server and back. If the communication is good, the ping time (milliseconds) will be shown, otherwise in case of error there will be a fault notification.

GMT: the Greenwich Mean Time.

A signal greater than -40dB is excellent (4 notches), a signal between -55 and -40dB is good (3 notches), a signal between -70 and -55dB is discreet (2 notches), a signal between -85 and -70dB is poor (1 notch) and a signal less than -85dB is insufficient (0 notches).

WARNING:

- **The proxy server is not supported.**
- **Only 2.4GHz WiFi networks are supported.**
- **To optimize its operation, it is recommended to install the boiler where the detected signal is at least -60dBm.**
- **The password entered when using the SCAN method must not exceed 40 characters.**
- **When using the smartphone connection method (PROV), only networks with OPEN or WPA-personal security may be connected.**
- **Moreover, the smartphone connection method (PROV) only allows one device at the time to be connected to the network generated by the boiler. When switching to a new device, the "Start connection" procedure must be repeated.**
- **WPS connection is currently not implemented.**

All basic router settings are normally accepted. However, if such settings are changed, it must be remembered that:

- **MAC filtering must be disabled or, if enabled, it must allow connection with the MAC address of the boiler (this information is under "Id" in the "Setting WiFi" menu).**
- **Check that the generated network has a frequency of 2.4GHz.**
- **Make sure that the DHCP server is enabled on the IPv4 version.**
- **Check that wireless scheduling is compatible with the expected time of use of the hot air generators.**



Returning to the "Setting WiFi" screen, the second page I will offer further options:

- 1) The first option, "WiFi monitor", opens a screen where it is possible to view further WiFi connectivity information.

```
WIFI CONNECTED
WRITE_REALTIME_FILE
LAST: 01 13:25
COUNTER: 014

ESC
```

In particular, in the first row shows the "WiFi" connectivity status:

WIFI DISCONNECTED: means that the boiler is not connected to the WiFi network.

WIFI CONNECTED: means that the boiler is ready to accept modifications through the smartphone app.

WIFI HOME: means that the boiler has priority as far as the changing of the parameters. If no keys are touched for one minute, the status switches to "WiFi CONNECTED" and the boiler is ready to accept changes through the smartphone app.

WIFI DEVICE: indicates that the smartphone is changing parameters on the boiler. One minute after the last change made through the smartphone application, the status switches to "WiFi CONNECTED" and the boiler is ready to accept new changes, including from a different smartphone.

- 2) The second row shows if the boiler is reading or writing from the server.

- 3) The third row, "LAST", shows the day and time when the last change was made through the smartphone application: "0" means Sunday, "1" means Monday, and so on.

- 4) The fourth row, "COUNTER", is a counter indicating the number of parameter changes made through the smartphone application. When the meter reaches "999", the counter is reset to zero.



Always in the second page of "Setting WiFi", the "Password APP" option can be used to change the password for accessing the smartphone application and control the operation of the boiler (the default password is "0000"). **It is recommended that the password is changed once the boiler is connected to the WiFi network.**

After launching the "MyBoiler" smartphone application (free to download from the Android and iOS stores), it will be necessary to enter the MAC address of the boiler ("Id: f8f005xxxxxxxx") and the password in order to connect.

The same password may be required by technical support if the user wishes to use the remote technical support service. In this case, the user gives to technical support the MAC address of the boiler and the password in order to allow them to connect remotely and check the operation and any faults.

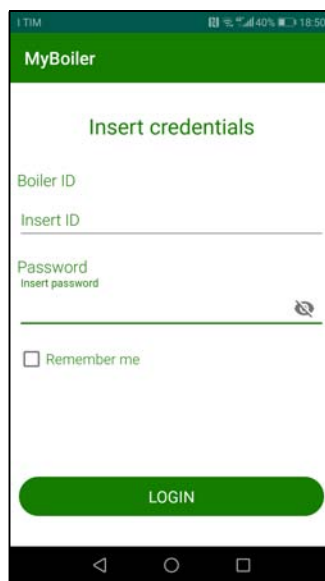
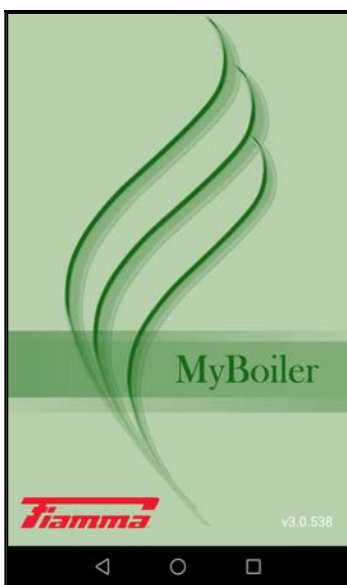

The last Option "Download certs" allows to load the "Certificate Authority" certificates using a special cable connected to a PC. This is useful if the boiler must be connected to a network with WPA/WPA2 Enterprise security. This operation should be completed by an authorised network administrator.



Programming

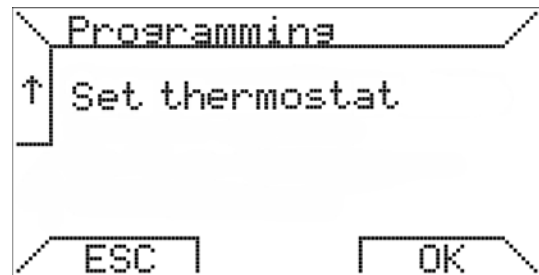
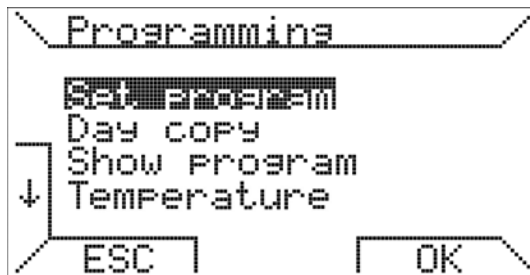

The "Programming" menu allows to manage weekly schedules. In this way, the boiler communicates the ON request following the set daily program. Time resolution is 30 minutes. Selecting "Set program", in the "Programming" sub-menu will open a screen where it is possible to change the weekly schedule.

In the "Day" row, use the ▲ (SW7) [+] and ▼ (SW6) [-] keys to select the day of the week to program. A reminder of the corresponding daily program is shown underneath.

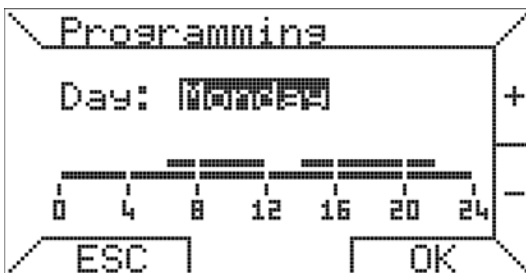

Taking "Monday" as an example, touch ■ (SW5) [OK] to enter time band programming.

The time bands are programmed in three steps:

- 1) Time band start (to select band start time)
- 2) Request (to set the heat request)
- 3) Time band end (to select the band end time)

In the first step, enter the start time using the ▲ (SW7) [+] and ▼ (SW6) [-] keys, with minimum intervals of 15 minutes, and confirm by touching ■ (SW5) [OK]. To abandon the programming for the selected day and switch to another day, simply touch ◀ (SW3) [ESC].

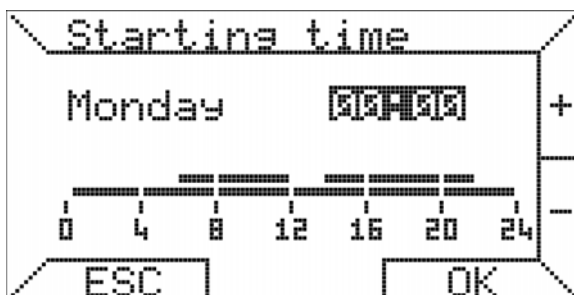



Then set the heat request, either "ON" or "OFF", moving around the display using the

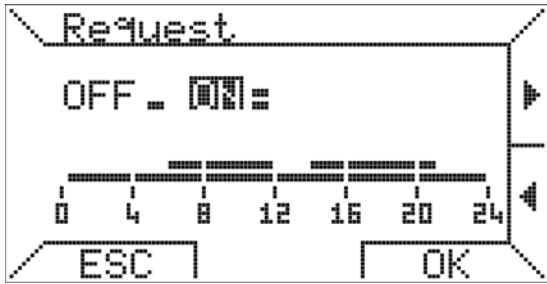

▲ (SW7) [▶] and ▼ (SW6) [◀] keys to select, followed by ■ (SW5) [OK] to confirm, or ◀ (SW3) [ESC] to change the band start time.

In the last step, select the time band end time and confirm using ■ (SW5) [OK].

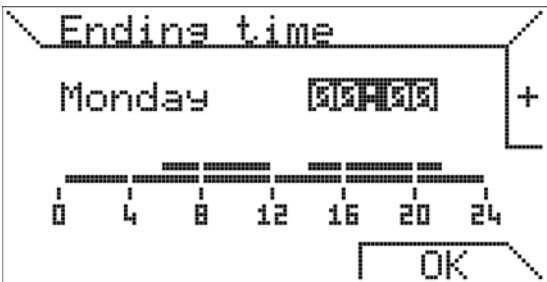

The time band end time cannot be before the time band start time; if the same time is selected as start and end time, the daily program is not updated.

The second item of the "Programming" menu allows to copy a program of one day to another day, by selecting the source day from which to copy at the top and the destination day to which to copy at the bottom.

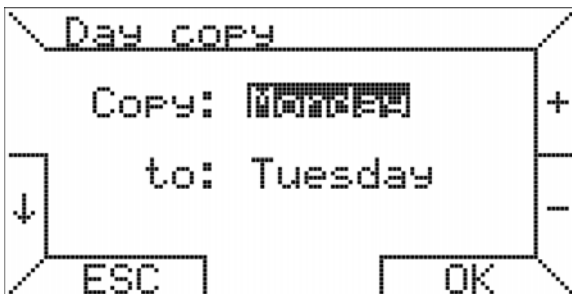

To set the same program for every day, simply select "ALL". When the ■ (SW5) [OK] button is pressed, a message confirms that the program has been copied.

The third item of the menu, "Show Program", allows to activate the weekly program and display some information, including the current time, the status of the heat request and the daily graph for the current day. It will then be necessary to set the weekly program to "ON" in order to activate it. This screen remains fixed until the ◀ (SW3) button is pressed [ESC].

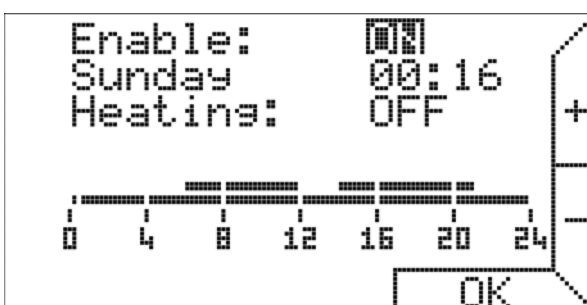



The last item, " **Set thermostat** ", allows to choose whether to link the request of switching on of the boiler in heating mode issued by the current daily program with the status of the room thermostat on the board.

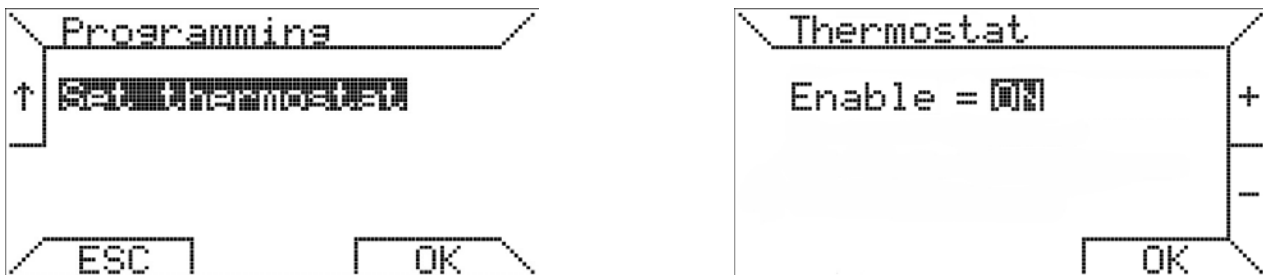

In particular, in the " **Set thermostat** " section, if the " **Enable** " option is **ON**, the boiler on in heating mode request generated by the daily program will only be considered by the board if the room thermostat on the boiler is closed. However, if the " **Enable** " option is **OFF**, the boiler will be switched on in heating mode as requested by the daily program, irrespective of the status of the room thermostat on the boiler.

INTERNAL POWER RESERVE

The display has an internal back-up power reserve that can counteract the absence of power for a few hours, so that the user will not have to reset the current time. However, the duration of the power reserve is variable depending on the humidity and the ambient temperature, as well as the age of the electronic components. For the power reserve to be fully operational, the device must have been correctly and continuously powered for at least two hours.

STORING DATA IN THE MEMORY

If even the internal power reserve described in the above paragraph is exhausted, the display still saves some settings and data in the memory: display settings, WiFi settings, weekly program and fault log.

It is possible to restore all the settings to the default values using the " **Factory reset** " submenu in the " **SETTING DISPLAY** " menu.

WARNING: Pressing the "Reset" key on the back of the display will not restore the factory settings.

BACKLIGHTING AND LED

The brightness of the display switches to maximum when a key is pressed, and returns to the minimum value set one minute after the last pressing of any keys. For energy efficiency purposes, after one minute only the LED under the ◀ (**SW3**) key remains on. In case of fault or boiler lock, all the LEDs come on and the LED under the ◀ (**SW3**) key flashes. In case of boiler lock, the display shows " **Res.** ". Use the ◀ (**SW3**) key to unlock the components that control the operation of the boiler.



TOUCH SCREEN CALIBRATION

A touch key calibration is completed the first time the power is switched on. Do not touch any keys until the language selection screen appears. In case of problems with the sensitivity of the touch keys after the first switch on, try to reset the display with the **"Reset"** button on the back.

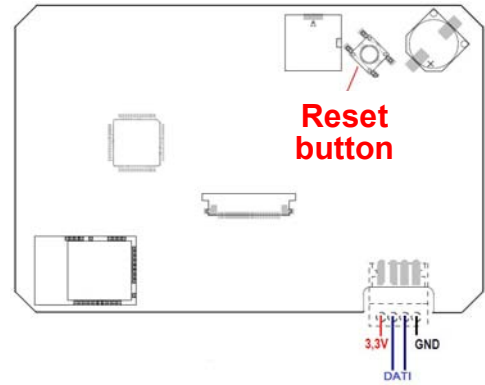

INSTALLATION WARNINGS

Observe the applicable national and European standards (e.g. EN60335-1/prEN50165) relating to electrical safety. Check the cables carefully before putting the boiler into operation; incorrect wiring can damage the devices and compromise the safety of the system. Enable and disable the control system only when there is no voltage. Avoid exposure of the system to water drops.



**INSTALLATION
TECHNICAL NOTE FOR THE INSTALLER AND THE MAINTENANCE TECHNICIAN.**

PLUMBING DIAGRAM

(version: Elektra Compact ... kW BP *Silver Touch*)

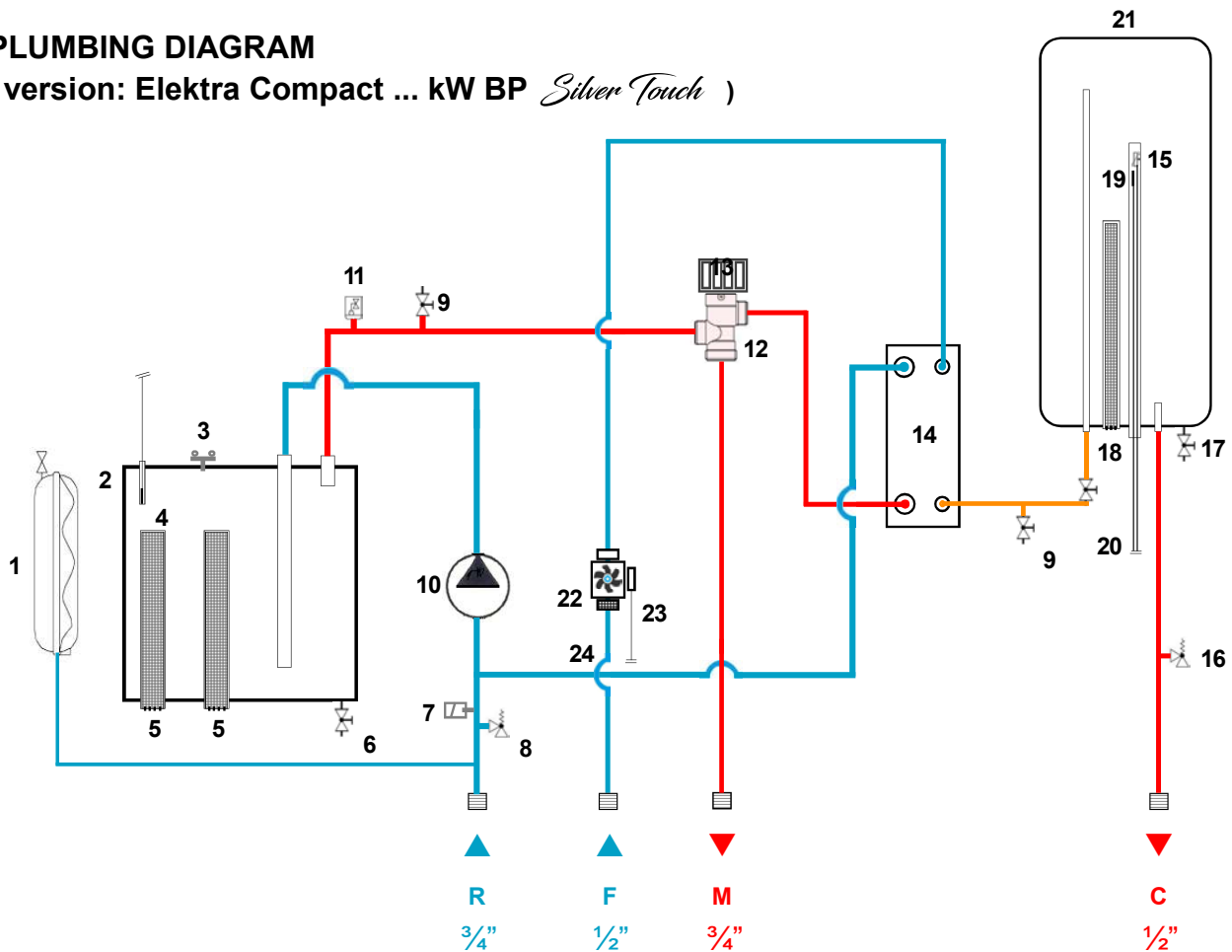

SYSTEM DIAGRAM LEGEND:

- 1 Central heating circuit expansion tank 9 litres
- 2 Electric boiler body 12 kW
- 3 Bimetal safety thermostat 100°C
- 4 Central heating water temperature probe
- 5 Heating elements 3x2 kW and/or 3x1 kW *
- 6 Boiler body drain tap
- 7 Pressure transducer
- 8 Safety valve 3 bar (central heating)
- 9 Exhaust tap (air vent)
- 10 Variable head circulator
- 11 Automatic vent valve
- 12 3-way electric diverter valve
- 13 diverter valve actuator (motor)
- 14 Stainless steel plate heat exchanger
- 15 Sanitary water storage tank temperature probe

- 16 Safety valve 6.5 bar (sanitary water)
- 17 Sanitary water storage tank drain tap
- 18 Sanitary water storage tank ceramic heating element 2 kW
- 19 Sanitary water storage tank safety thermostat
- 20 Sanitary water flow regulator tap
- 21 Vitrified sanitary water storage tank 37 litres
- 22 Sanitary water flow meter
- 23 Sanitary water flow meter probe
- 24 Cold water inlet filter

- R** Central heating system return
- F** Sanitary cold water inlet
- M** Central heating system delivery
- C** Sanitary hot water output

* As far as the other models, the only differences are in the number of electric heating elements; the 6 kW version has two 3 kW heating elements, the 7/8/9 kW version has one 6 kW heating element and one 3 kW heating element, the 12 kW version has two 6 kW heating elements, the 15 kW version has two 6 kW heating elements and one 3 kW heating element and the 18 kW version has three 6 kW heating elements.



WIRING DIAGRAM (single phase)

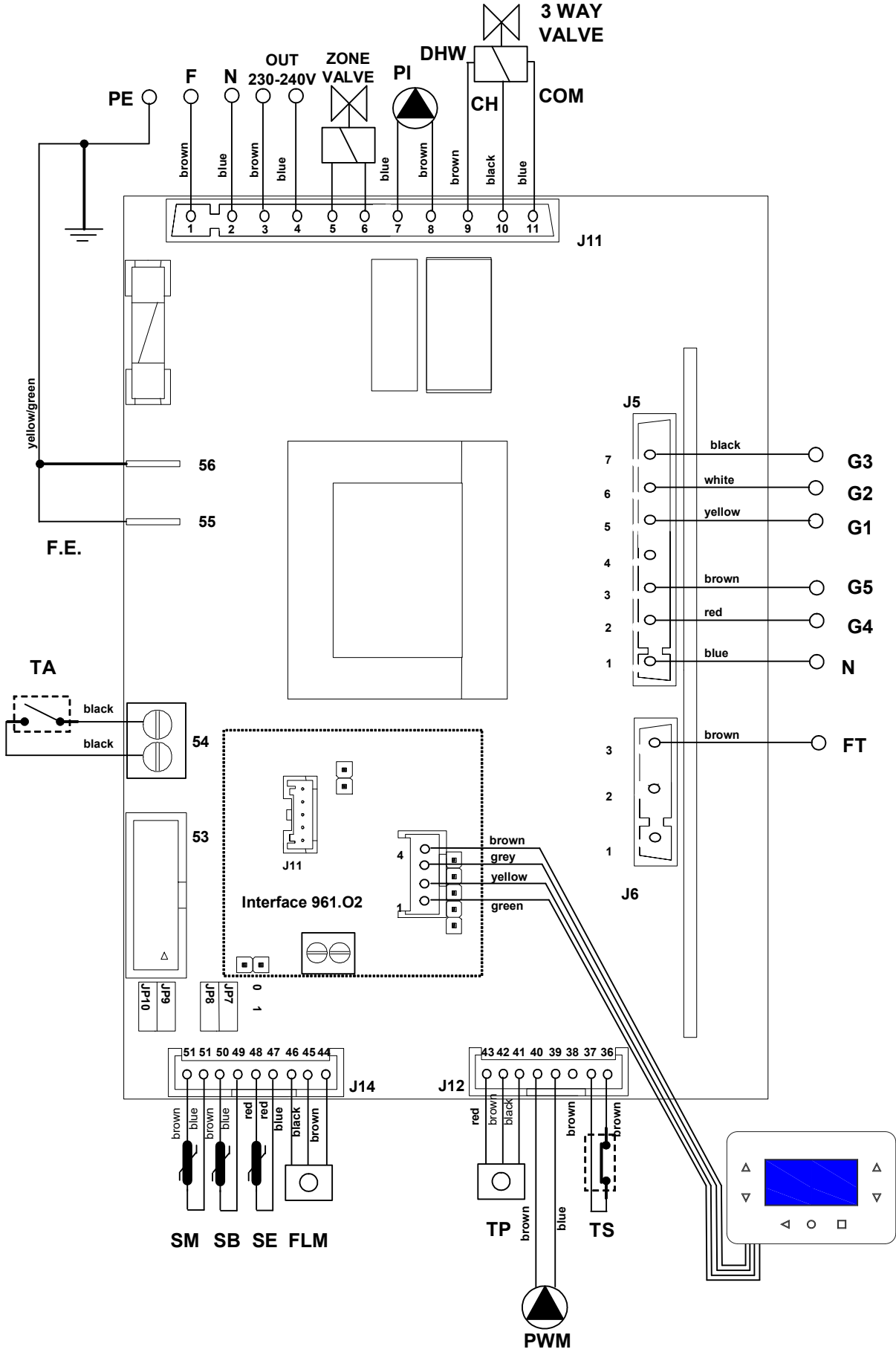



GENERAL WIRING DIAGRAM - POWER (Single-phase)

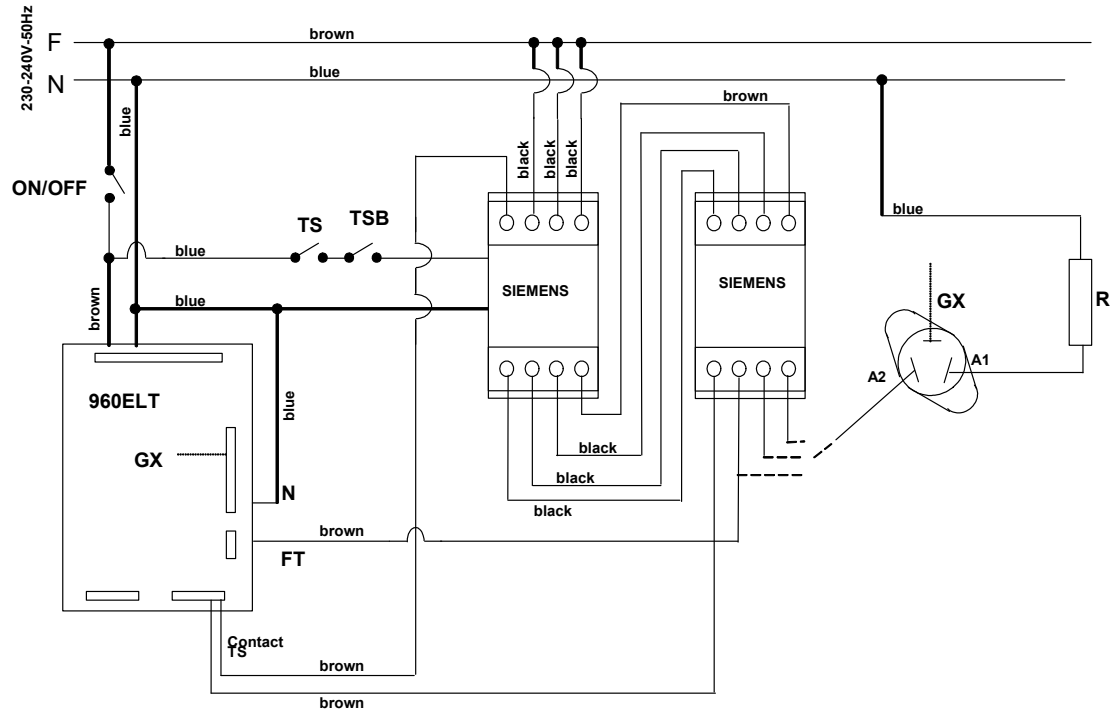

Legend of wiring diagrams

Phase	F
Neutral	N
Contactor sectioned phase	FT
Pump	PI
Sanitary water diverter valve control	DHW
Central heating diverter valve control	CH
Diverter valve common	COM
Sanitary water flow meter	FLM
Gate command, triac no. 1 (12 kW version - 4 kW load)	G1
Gate command, triac no. 2 (12 kW version - 2 kW load)	G2
Gate command, triac no. 3 (12 kW version - 4 kW load)	G3
Gate command, triac no. 4 (12 kW version - 2 kW load)	G4
Gate command, triac no. 5 (2 kW internal storage tank load)	G5
Delivery probe	SM
External probe	SE
Sanitary water storage tank probe	SB
Pressure transducer	TP
Safety thermostat	TS
Sanitary water storage tank safety thermostat	TSB
Room thermostat (prearranged terminals)	TA
Main switch (also disconnects the board)	ON/OFF
Functional earth derived from the earth point	F.E.
Safety earth point on the application	PE



TRIAC - Wiring diagram

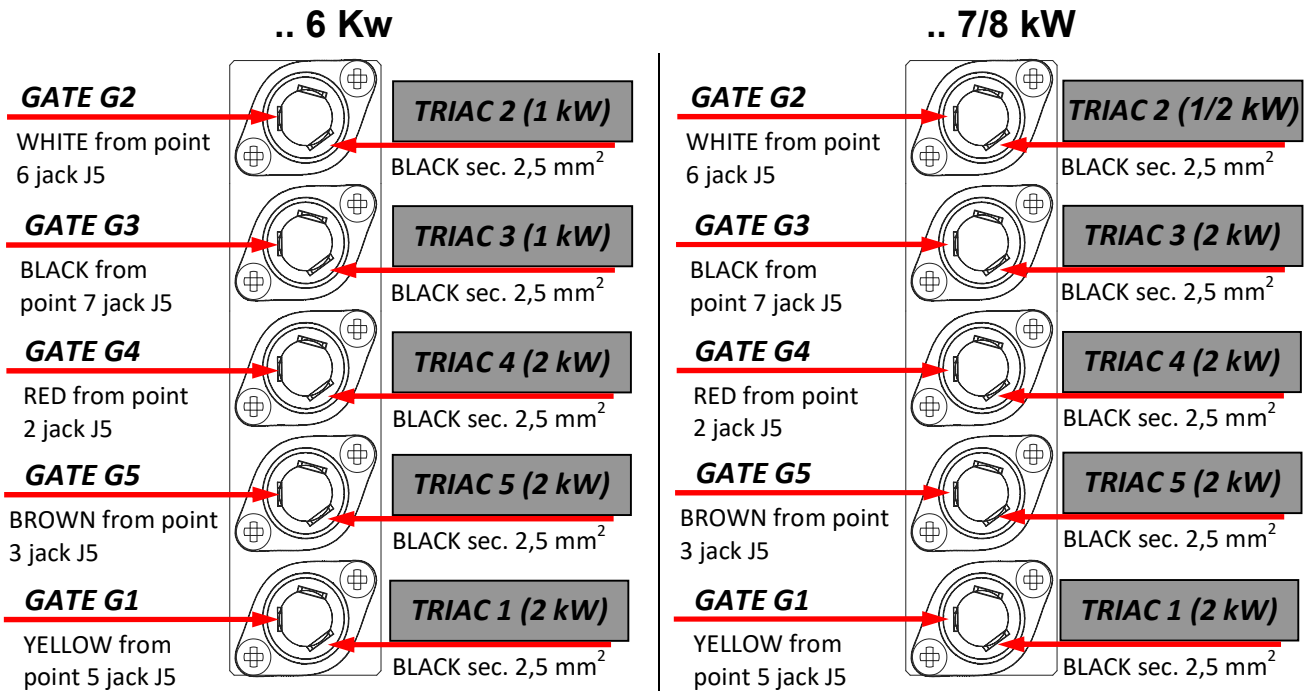
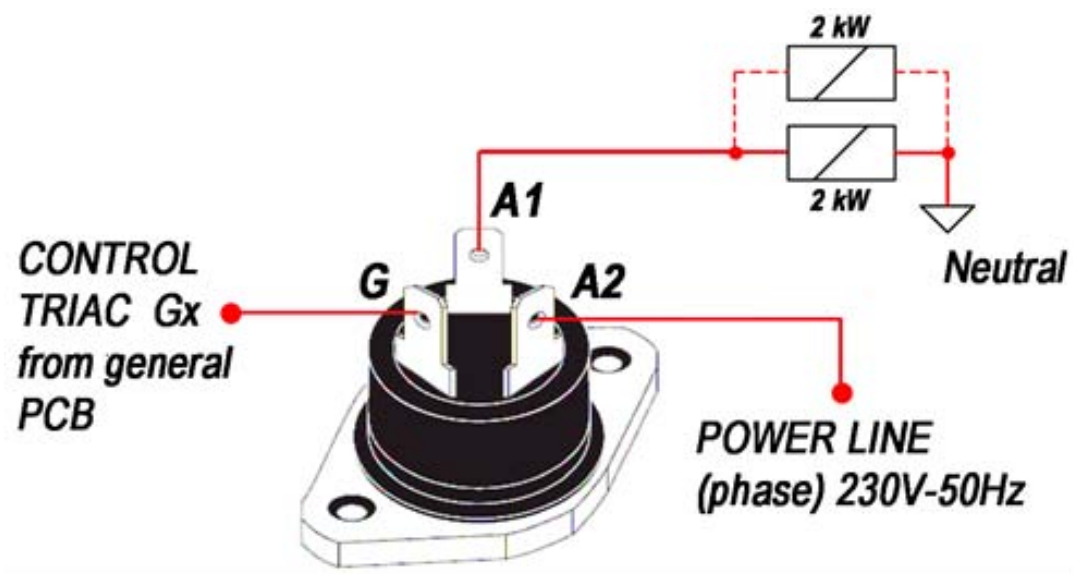



TRIAC - Wiring diagram

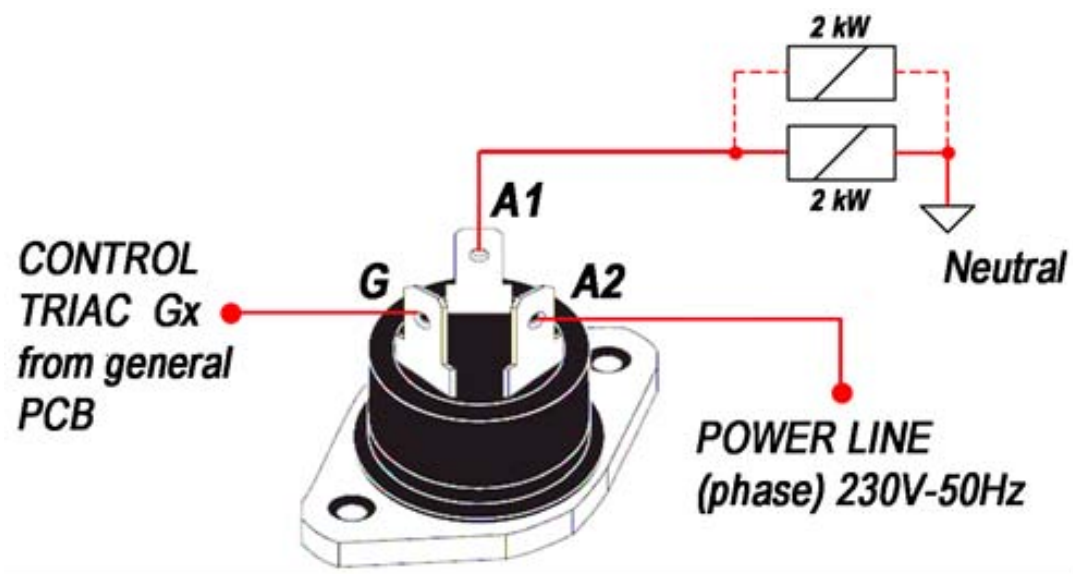

.. 9 Kw

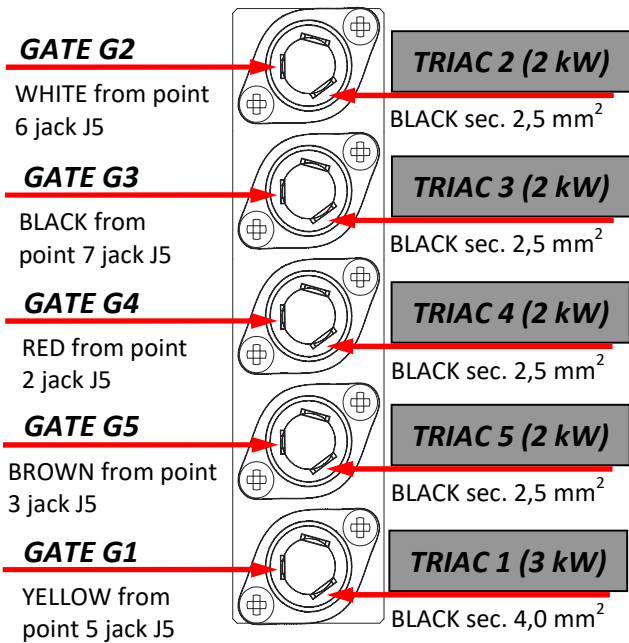

..12 kW

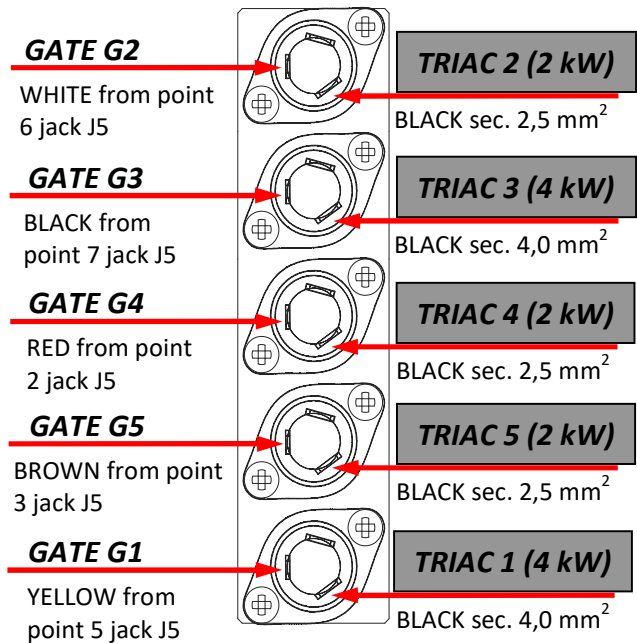



TRIAC - Wiring diagram

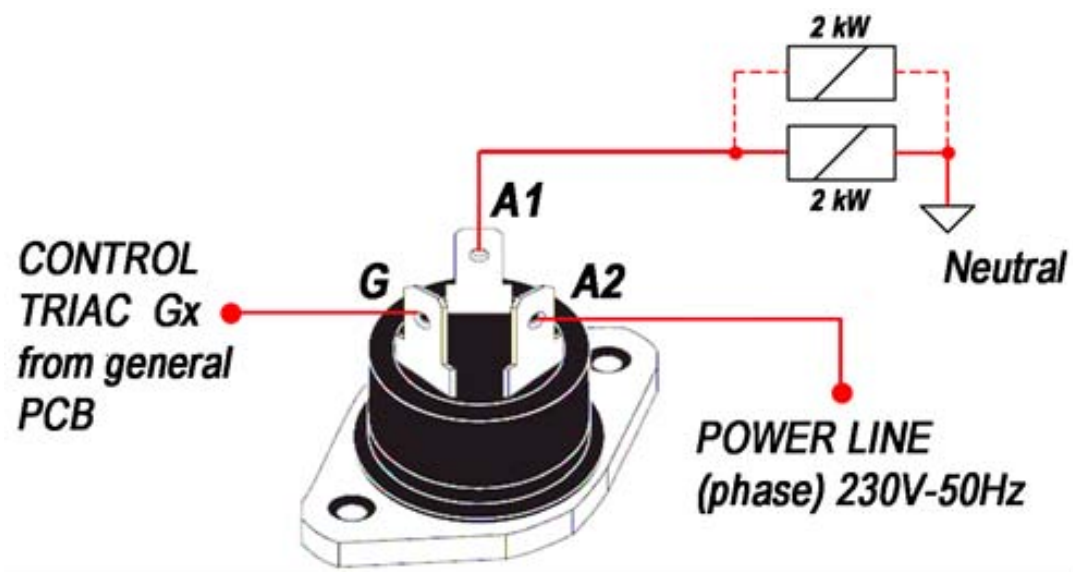

..15/18 kW

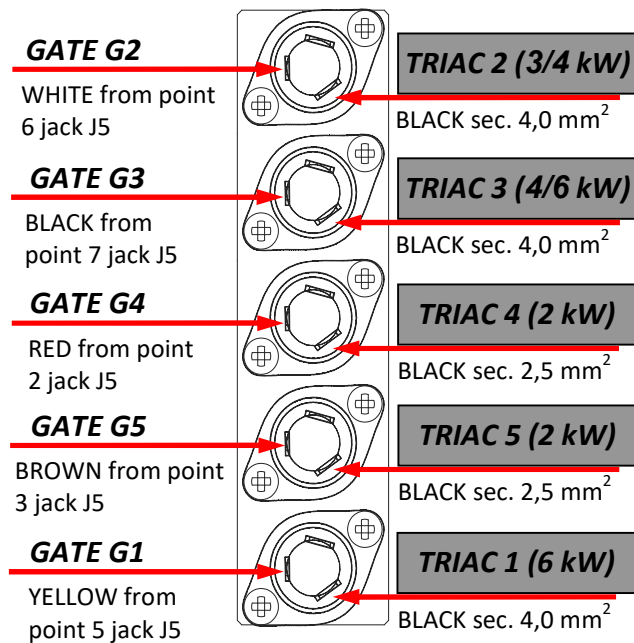



FACTORY CONSTANTS

Function	Value
Anti-legionella range temperature	65 °C
Anti-legionella activation interval	7 days
Maximum primary circuit temperature	80 °C
Circulator lock prevention operation time	10 sec
Circulator lock prevention activation time	24 hours
Anti-freeze temperature On (circulator only)	< 8 °C
Anti-freeze Temperature On (circulator and power)	< 5 °C
Anti-freeze Temperature Off	> 20 °C

SETPOINTS AND PARAMETERS

Function	Default	Range
Central heating setpoint	60 °C	30 - 75 °C
Underfloor central heating setpoint	30 °C	10 - 40 °C
Room setpoint (with external probe present)	20 °C	10 - 30 °C
Sanitary water storage tank setpoint	60 °C	30 - 65 °C

PARAMETERS

Function	Display	Def.	Range
External probe enable (SE)	idx: 001	0	0 - 1
Building dispersion coefficient	idx: 002	35	5 - 35 °C
Sanitary water post-circulation duration	idx: 003	15	1 - 180 sec
Central heating post-circulation duration	idx: 004	30	1 - 180 sec
Primary exchanger ON delay	idx: 005	0	0 - 240 sec
Min. temperature of primary exchanger for circulator ON	idx: 006	30	0 - 50 °C
Sanitary water delivery differential	idx: 007	15	0 - 20 °C
Type of sanitary water storage tank	idx: 008	0	0 = internal with probe 1 = external with thermostat 2 = external with probe
Type of sanitary water request sensor	idx: 009	1	0 = flow switch + three-way pneumatic 1 = flow meter + three-way electric
PWM circulator operation speed	idx: 010	4	1 = 400 l/h 3 = 1,000 l/h 2 = 800 l/h 4 = 1,200 l/h
Boiler power selection	idx: 011	3	1 - 4
System pressure sensor type	idx: 012	1	0 - 2



Value idx: 011	Total power [kW]	No. TRIAC	No. of heating elements used and power of each element	G1 [kW]	G2 [kW]	G3 [kW]	G4 [kW]	G5 [kW]
002	6	5	no. 2 heating elements, power 3 x 1kW	2	1	1	2	2
002	8	5	no. 1 heating elements, power 3 x 1kW no. 1 heating elements, power 3 x 2kW	2	2	2	2	2
002	9	5	no. 1 heating elements, power 3 x 1kW no. 1 heating elements, power 3 x 2kW	3	2	2	2	2
003	12	5	no. 2 heating elements, power 3 x 2kW	4	2	4	2	2
004	18	5	no. 3 heating elements, power 3 x 2kW	6	4	6	2	2

Value idx: 012	Description
val: 000	Boiler with PSA water pressure switch connected to poles 36 and 37 and safety thermostat connected to poles 42 and 43 (compatibility for 960ELT.FG3.00 board replacement)
val: 001	Boiler with safety thermostat connected to poles 36 and 37 and system pressure transducer connected to poles 41, 42 and 43
val: 002	The board is configured for operation with idx: 012 val:001, but the presence of errors F1 and F10 is ignored. This is necessary in the event that the pressure transducer fails and technical support does not have the spare part available. However, the boiler has a needle hydrometer that indicates the correct pressure of the system. When idx: 012 val:002, the pressure shown on the display is 0.0 bar

SELECTION JUMPERS (move jumpers with the board not powered)



Jumper	0	1	Default
JP7	High temperature heating system (radiators)	Low temperature heating system (floor)	0
JP8	Combined application	Central heating only application	0
JP9	Sanitary water system with storage tank	Instantaneous sanitary water system	0
JP10	Boiler application	Not usable	0



PRIMARY EXCHANGER MANAGEMENT (BOILER BODY)

Depending on the power level required during the "heat demand", all or part of the controls from G1 to G4 relating to the primary exchanger are switched on. The activation of each command is controlled within an interval of 4 seconds. The higher the power required, the more the command will remain active in this interval. The power during a central heating or sanitary hot water request is calculated using a PID algorithm.

Below are two examples for powers equal to 40% and 60% of the total power (12 kW).

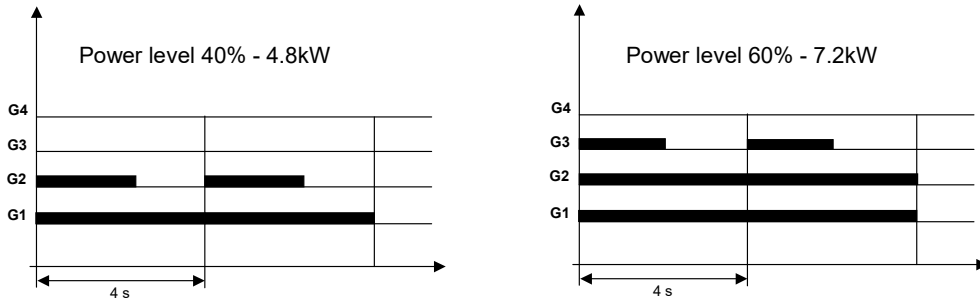

In case of simultaneous request of heating and sanitary hot water, the commands G1÷G4 relating to the primary exchanger, and G5, relating to the sanitary water storage heater are operated as follows:

Boiler status	Primary G1÷G4	Storage tank G5
Central heating request only	G1 ÷ G4 = modulation	G5 = OFF
Central heating + sanitary hot water request	G1 ÷ G3 = modulation G4 = OFF	G5 = ON
Central heating + micro sanitary hot water request	G1 ÷ G3 = modulation G4 = OFF	G5 = ON

Rotation of commands

The order in which the G1÷G4 triac commands are switched on is rotated every hour, so that the use of all the heating elements is evenly distributed over time.

EXTERNAL PROBE MANAGEMENT (IF)

Installation and sliding temperature operation

The connection of the External Probe (SE) requires the use of the Original FIAMMA Kit code F.532, offered as part of the accessories for Elektra series electric boilers. The electric connection must be to the terminals (S and E) outside the main electric panel already arranged in the standard wiring of the boiler. The connection requires connection cables and wires with a minimum cross section of 1.5 mm, possibly avoiding the proximity of power lines or digital lines of inverters or anything else not compatible. After connection, the external probe must be enabled by entering a variation of parameter `idx: 001` from 0 to 1.





The setpoint followed by the central heating delivery probe will be calculated using the following formula:

$$T_{ch} [^{\circ}C] = [(T_{room} [^{\circ}C] - T_{ext} [^{\circ}C]) * dc/10] + T_{room} [^{\circ}C]$$

T_{ch} : central heating setpoint calculated by the system

T_{room} : room temperature set by the user

T_{ext} : external temperature measured by the probe

dc: dispersion coefficient of the building, set using the parameter **idx: 002**.

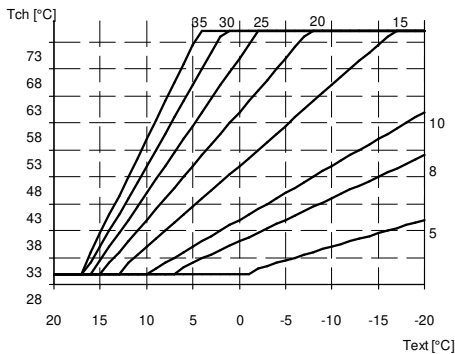

Examples of curves with T_{room} set to 20°C and JP7 = 0

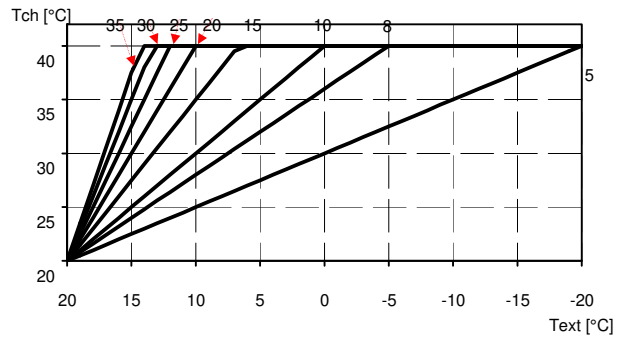

Examples of curves with T_{room} set to 20°C and JP7 = 1

HEATING REQUEST

When the room thermostat (TA) contact is closed, or following a request by the weekly program, if the board is in winter mode the system pump is activated only if the primary exchanger temperature is higher than the temperature set using parameter **idx: 006**. If the temperature value detected by the primary exchanger probe is lower than the delivery setpoint, the triacs are switched on in sequence based on the required power. This only happens after a time that can be set using the parameter **idx: 005**, to allow, for example, the opening of any zone valves. The instantaneous power of the boiler and the control of the G1÷G4 triacs is through the PID regulator. If the request of the internal sanitary water storage tank with probe (**JP8 = 0** and **P8 = 0**) is activated at the same time, only commands G1, G2 and G3 are activated, to avoid exceeding the nominal boiler output (6, 12 or 18 kW). At the end of the request the circulator remains powered for a time equal to the value set using the parameter **idx: 004**.

INTERNAL STORAGE TANK REQUEST (JP9 = 0 and P8 = 0)

Stand-by or with simultaneous heating request:

In this case, if the temperature detected by the storage tank probe (SB) is below the storage tank setpoint -1°C, the G5 command for the storage tank heater is activated. When the temperature detected by the storage tank probe is higher than the storage tank setpoint, the G5 command is deactivated. The activation of G5 causes G4 (2 kW) to switch off, so that the maximum total consumption of the system is always 6/7/8/9/12/15/18 kW (depending on the model).



Sanitary water flow meter request:

When a request is received from the sanitary water flow meter (FLM), the G5 command for the storage tank heater (2 kW) is activated independently as long as the storage tank temperature remains below 70°C.

In "ECONOMY" mode, no primary exchanger heating element is activated.

In "COMFORT" mode, commands G1, G2, G3 relating to the primary exchanger are also controlled at the same time, bringing the delivery temperature to the storage tank setpoint value + a differential that can be set using the parameter `idx: 007`. At the end of the request the circulator remains powered for a time equal to the value set using the parameter `idx: 003`.

Primary exchanger preheating:

In stand-by conditions with "COMFORT" mode active, the primary exchanger is kept at temperature in order to guarantee a prompt response in case of sanitary water request. The primary exchanger is kept at a temperature equal to the storage tank setpoint plus a temperature delta that can be set using the parameter `idx: 007`. The maximum power used to manage this phase is 6 kW.

In all the above cases, if there is an electric diverter valve (**P9** = 1), this is active in sanitary hot water position (230V~ on pole 9). At the end of the post-circulation phase, the diverter valve is activated for a short period (switching from DHW position to CH position and back to DHW position) in order to avoid locking due to long period of inactivity.

SANITARY WATER SYSTEM "ECONOMY" / "COMFORT" FUNCTION

In "ECONOMY" mode, no primary exchanger heating element is activated.

When the "COMFORT" function is active in stand-by conditions, the primary exchanger is kept at temperature in order to guarantee a prompt response in case of sanitary water request. The main exchanger is kept at a temperature equal to the sanitary water setpoint temperature plus a differential adjustable using the parameter `idx: 007`.

ANTI-FREEZE FUNCTION

When the delivery probe detects a temperature below 7°C, the circulator is activated. If the temperature drops below 4°C, the main exchanger is switched on until the delivery temperature is raised to 20°C. The anti-freeze function is also active when the boiler is OFF (in stand-by mode but with the illuminated main switch on).

ANTI-LEGIONELLA FUNCTION

The system continuously monitors the temperature of the storage tank. If the temperature does not reach 65 °C within a certain period of time, the storage tank heating element is automatically switched on in order to prevent the formation of bacteria. The anti-legionella function is activated 3 hours after the boiler is switched on for the first time, and then every 7 days.



CIRCULATOR LOCK PREVENTION

When the circulator has not performed an operation cycle in a 24h period, it is activated for 10 sec. to avoid locking due to long period of inactivity. At the end of the post-circulation phase, activated following the demand for sanitary hot water, the electric diverter valve is activated for 2 sec. in order to avoid locking due to long period of inactivity.

GRUNDFOS UPM3 "K" FLEX-AS Version 2020 PUMP INSTRUCTIONS



	OPERATING PANEL	CONTROL MODE
0		PWM PROFILE A 1 - SIGNAL OFF
		PWM PROFILE A 1 - PWM SIGNAL ON
1		PWM PROFILE A 2 - SIGNAL OFF
		PWM PROFILE A 2 - PWM SIGNAL ON
2		PWM PROFILE A 3 - SIGNAL OFF
		PWM PROFILE A 3 - PWM SIGNAL ON

FLASH INDICATION	
	1 FLASH PER SECOND
	8 FLASHES PER SECOND

ALARM STATUS	FAULT
	BLOCKED
	LOW VOLTAGE
	ELECTRICAL ERROR

The new FLEX-AS (K) pump version 2020 has three manually adjustable speeds and 4 flow rate reductions (with speed reduction) via the PWM signal, which can be set from the boiler control panel. A total of ten circulator speeds can be set, with ten corresponding separate flow rates.

Pump programming

Manually select the maximum speed profile using the key, then use the boiler control panel to select the parameter `idx: 010` and choose one of the four flow rates available for each speed, setting the values from 1 to 4. Set 1 for minimum flow rate, or 4 for maximum flow rate, set 2 and/or 3 for intermediate flow rates. According to the diagram in the table above, the maximum value of each speed is represented by the LED flashing once per second (parameter `idx: 010` set to value 4); when PWM programming is activated, from value 3 to 1 the green LED flashes with a frequency of 8 flashes/second. The maximum speed is indicated by the first Yellow LED under the III symbol, the intermediate speed by the second Yellow LED under the II symbol, and the first speed by the third Yellow LED under the I symbol (front view, from left to right).



FAULT CODES

Faults are indicated by an " **ERROR F X** " message, with X being the corresponding error code.

"ERROR" Code	Meaning
F 1	Functional system shutdown due to system pressure below 0.7 bar (idx: 012 val:1)
F 3	Central heating probe fault (SM)
F 4	Storage tank probe fault (SB)
F 8	Safety thermostat (TS) trip. To reset the system press ◀(SW3) [Res.]
F 9	EEPROM memory hardware failure
F 10	System pressure higher than 2.0 bar, with functional system shutdown if the pressure exceeds 2.8 bar (idx: 012 val:1)

UNLOCKING THE APPLIANCE (RESET)

To unlock the boiler press ◀ (SW3) [Res.]



SPARE PARTS

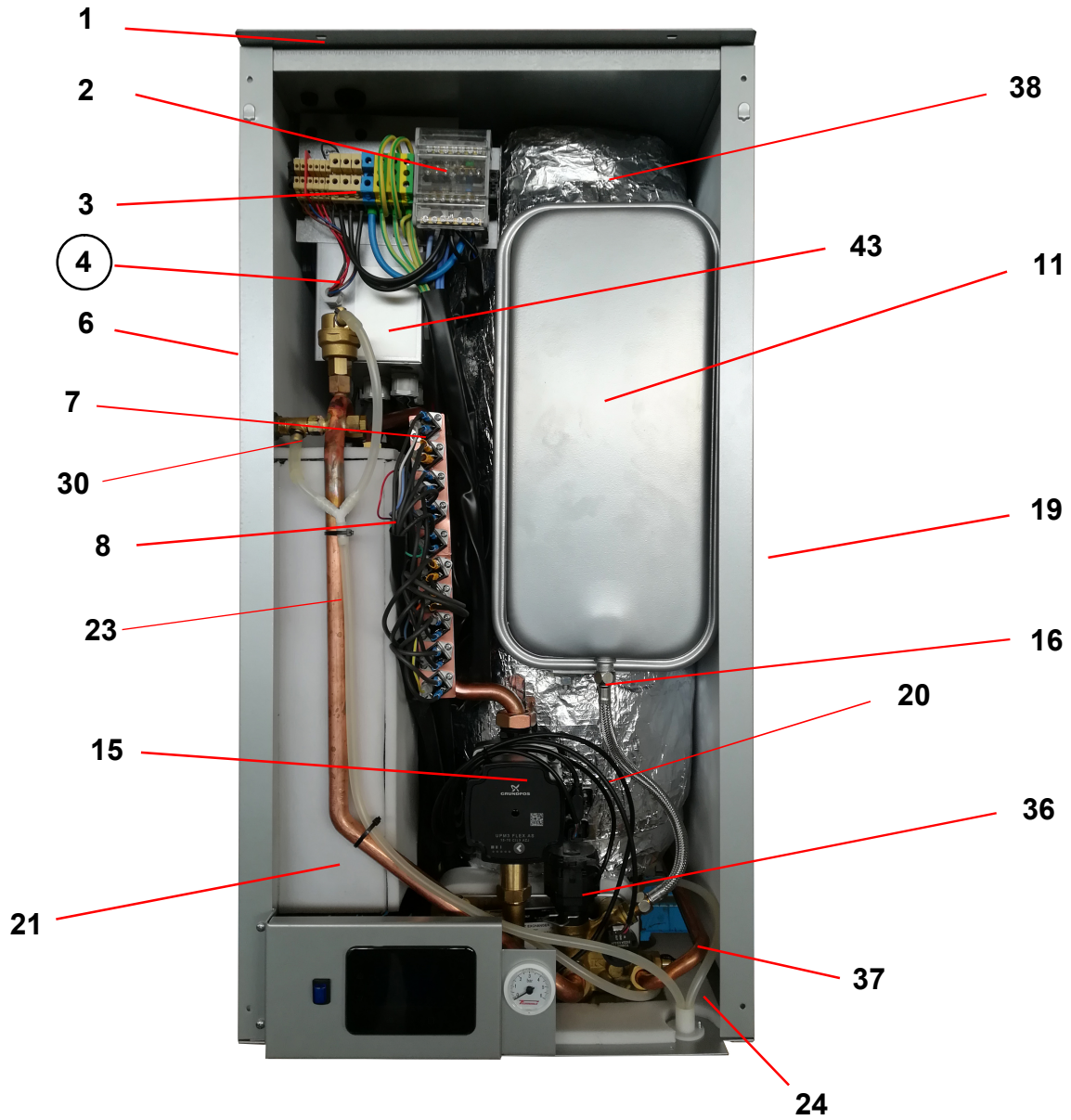

4 Detail view: Electric Box

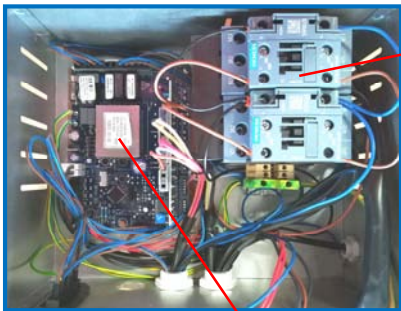

26

Detail view: Body / Heating Elements

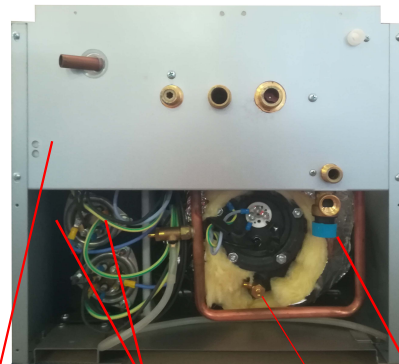

25

29

22

37



Boiler front

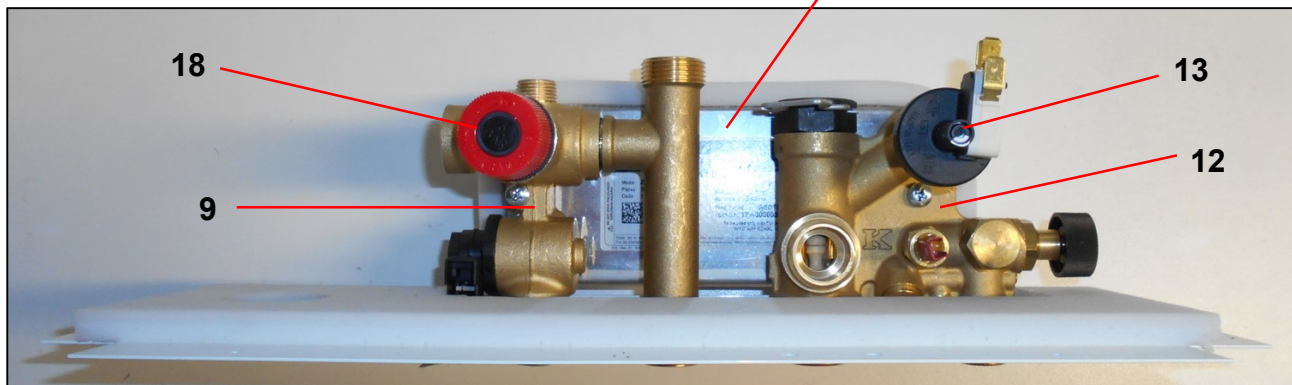
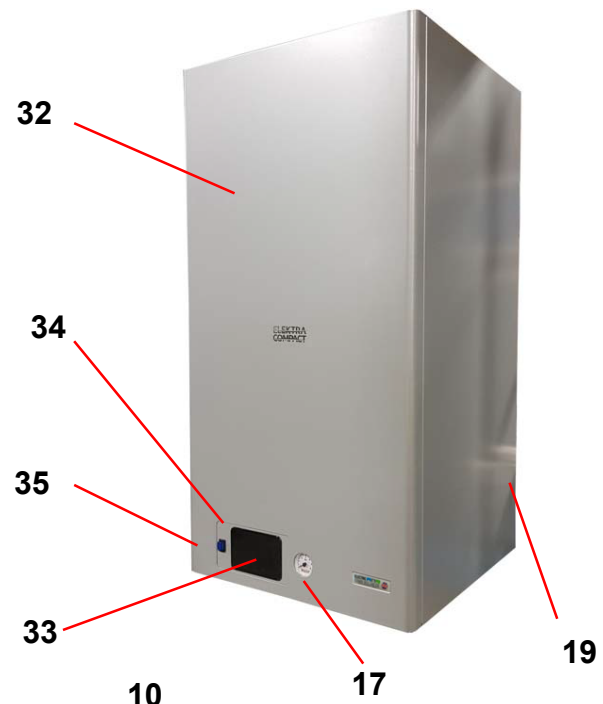
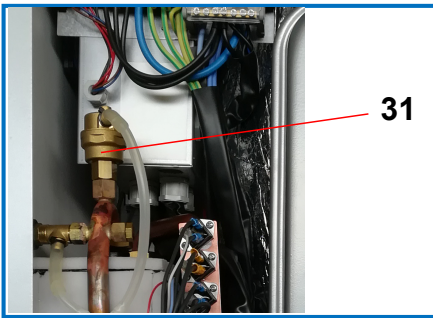
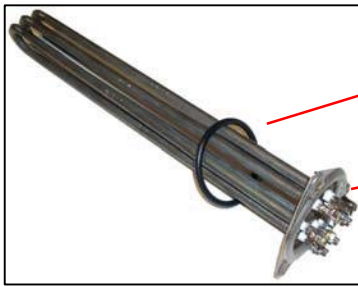

Detail view: Storage tank Flange/Probe/Heating Element/Anode assembly



The storage tank flange assembly includes, in one single vitrified piece, the probe support sheath, the heating element support sheath and the support and inspection flange. The replacement of the magnesium anode requires the removal of the assembly. The replacement of the electric heating element does not require emptying the storage tank, as it is inside a vitrified steel hermetic sheath.

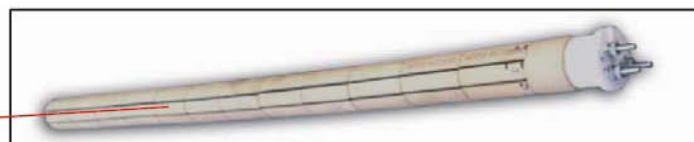



Spare parts legend

1	Elektra Compact BP upper sheet metal cover.....	Cod.P.8096
2	Elektra Compact four-pole power terminal block.....	Cod.P.2054
3	Power supply line terminal 230-240 V (L) x 10 pcs.....	Cod.FGB.2073
	Neutral power supply terminal 230-240 V (N) x 10 pcs.....	Cod.FGB.2072
	Earth terminal (\pm) x 10 pcs.....	Cod.FGB.2074
4	General electric box (contactor/electronic board panel).....	
5	Touch display connection cable.....	Cod.P.7981
6	Left side shell.....	Cod.P.8098
7	Power Triacs (40 A - 600 V).....	Cod.P.2293
8	Return pipe (pump/body).....	Cod.P.7644
9	Return assembly - cold water.....	Cod.FGB.212
10	Elektra Compact 6/7/8kW BP plate heat exchanger.....	Cod.P.7585
	Elektra Compact 9/12kW BP plate heat exchanger.....	Cod.FGB.222
	Elektra Compact 15/18kW BP plate heat exchanger.....	Cod.P.7811
11	Elektra Compact BP 9 litre expansion tank.....	Cod.P.7815
12	Delivery assembly - diverter valve.....	Cod.FGB.214
13	Pressure transducer (max./min. pressure).....	Cod.P.8062
14	Return pipe (assembly/pump).....	Cod.FGB.211
15	Variable head circulator (electronic pump).....	Cod.P.7326
16	Expansion vessel hose.....	Cod.P.1572
17	Hydrometer.....	Cod.FGB.221
18	Central heating safety valve 0.3 MPa (3 bar).....	Cod.P.7602
19	Right side shell.....	Cod.P.8097
20	Elektra Compact BP Wiring.....	Cod.P.7646
21	Elektra Compact 6/7/8/9/12 BP boiler body.....	Cod.F.1958
	Elektra Compact 15/18 BP boiler body.....	Cod.F.1959
22	Drain tap 1/4".....	Cod.FGB.225
23	Elektra Compact BP delivery pipe.....	Cod.P.7642
24	Elektra Compact BP bottom grid.....	Cod.P.8164
25	Hydraulic connection template.....	Cod.P.8163
26	Elektra Compact C/N/BP-L/BP electronic board.....	Cod.P.2057
27	Elektra Compact 6-8-9-12-18kW power contactor.....	Cod.P.2153
28	O-Ring seal x heating element 3x2 kW.....	Cod.FGB.238
29	Elektra Compact 6/7/8/9/15 BP heating element 3x1 kW.....	Cod.P.7410
	Elektra Compact 7/8/9/12/15/18 BP heating element 3x2 kW.....	Cod.FGB.224
30	Contact safety thermostat 100°C.....	Cod.P.1195



31	Automatic vent valve	Cod.FGB.228
32	Elektra Compact BP Silver Touch front cover.....	Cod.P.7949
33	Touch Display.....	Cod.P.7980
34	Elektra Compact BP Silver Touch Instrument Panel.....	Cod.P.7947
35	Illuminated main switch.....	Cod.P.7983
36	Diverter valve motor (actuator).....	Cod.FGB.223
37	Sanitary water safety valve 0.65 MPa (6.5 bar)	Cod.P.7540
38	Storage tank 37 litres	Cod.FGB.235
39	Flange/Probe sheath/Heating Element sheath assembly.....	Cod.P.2163
40	Storage tank magnesium anode.....	Cod.P.2165
41	Storage tank flange gasket.....	Cod.P.2166
42	2kW Ceramic heating element for sanitary hot water storage tank...Cod.P.2167	
43	Storage tank safety thermostat.....	Cod.FGB.236
44	Touch display connection module (card).....	Cod.P.7982
45	Cold water storage tank inlet pipe.....	Cod.FGB.210
46	Elektra Compact BP hot water assembly	Cod.FGB.226

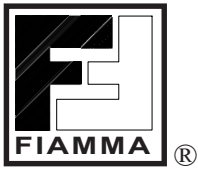

FIAMMA
GAS & ELECTRIC BOILER



**DICHIARAZIONE DI
CONFORMITA'**



**DECLARATION OF
CONFORMITY**

In accordo con - *According to:*

2014/35/EU	Direttiva Bassa Tensione (BT) – <i>Low Voltage Directive (LVD).</i>
2004/30/EU	Direttiva Compatibilità Elettromagnetica - <i>Electromagnetic compatibility Directive (EMC).</i>
2011/65/EU	Direttiva restrizione uso di determinate sostanze pericolose in apparecchiature elettriche ed elettroniche. <i>Directive on the restriction of use of certain hazardous substances (RoHS).</i>
1935/2004	Regolamento riguardante i materiali e gli oggetti destinati a venire a contatto con i prodotti alimentari. <i>Regulation on materials and articles intended to come into contact with food.</i>
813/2013/EU	Regolamento per la progettazione ecocompatibile degli apparecchi per il riscaldamento d'ambiente e degli apparecchi di riscaldamento misti. - <i>Ecodesign requirements for space heaters and combination heaters.</i>
811/2013/EU	Regolamento riguardante l'etichettatura indicante il consumo d'energia degli apparecchi per il riscaldamento d'ambiente, degli apparecchi di riscaldamento misti. <i>Regulation regard to the energy labelling of space heaters, combination heaters, packages of space heater, temperature control and solar device and packages of combination heater, temperature control and solar device.</i>

N° di identificazione - <i>Identification No. :</i>	Vedi numero di matricola / <i>See the serial number</i>
Costruttore - <i>Manufacturer :</i>	FIAMMA GIRO s.r.l.
Indirizzo- <i>Address :</i>	via L. Landucci n°.2/B - 51100 PISTOIA - ITALY
Telefono - <i>Telephone :</i>	(+39).0573.532812
Fax / e-mail – <i>Telefax / E-mail :</i>	(+39).0573.532890 - info@fiammagiro.it
Tipo di apparecchio - <i>Type of equipment :</i>	Caldia murale elettrica / <i>Electric wall boiler</i>
Marchio commerciale - <i>Trademark :</i>	 (dicitura FIAMMA / FIAMMA marked)
Tipo / Modello – <i>Type / Model :</i>	Vedi Modello su targhetta dati / <i>See the model in data code</i> ELEKTRA.. 6 ÷ 24 ... <i>ELEKTRA.. 6 ÷ 24...</i>

Le norme armonizzate o le specifiche tecniche (designazioni) che sono state applicate in accordo con le regole della buona arte in materia di sicurezza in vigore nella Unione Europea sono :

The following harmonised standards or technical specifications (designations) which comply with good engineering practice in safety matters in force within the European Union have been applied :

Norme o altri documenti normativi - *Standards or other normative documents*

IEC 60335-1:2010+A1:2013+A2:2016 – IEC 60335-2-21:2012+A1:2018

EN 60335-2-21:2003+A1:2005+A2:2008

EN 60335-1:2012+A11:2014+A13:2017+A1:2019+A2:2019+A14:2019

Le caldaie della serie ELEKTRA.. sono certificate CB con documento n°.IT-22669/A1.

The boilers of the ELEKTRA.. series are CB certified with document number IT-22669/A1.

Rapporto di collaudo - Schede tecniche

Test report-Technical file

Nr. EP20-0059463-01 rev.1

EN 61000-3-11:2011; EN 61000-3-12:2011; EN 61000-3-11:2001; EN 61000-3-11:2000; EN 55014-1; EN 55014-2

Le caldaie della serie ELEKTRA sono state verificate con Test-Report n°.TRA-030968-36-00A

The boilers of the ELEKTRA series have been verified with Test-Report n°.TRA-030968-36-00A.



In qualità di costruttore e/o rappresentante autorizzato della società all'interno della Unione Europea, si dichiara sotto la propria responsabilità che gli apparecchi sono conformi alle esigenze essenziali previste dalle Direttive e Regolamenti su menzionate/i.
As the manufacturer's authorized representative established within European Union, we declare under our sole responsibility that the equipment follows the provisions of the Directives and Regulations stated above.

Pistoia, 15/07/2022

Giro Luca

presidente consiglio di amministrazione
Board Chairman of administration



SEDE: 51100 PISTOIA - ITALIA - Via L. Landucci, 2 z.i. - Tel. (+39).0573.532812 - Telefax: (+39).0573.532890. E-mail: fiammaPT@fiammagiro.it
Cap. soc. Euro.40.000,00 Int.versato. - P.I.V.A. 01432870473 - R.E.A. 149197 - Albo Art. PT49948

FILIALE: 37049 VILLA BARTOLOMEA (VR) - ITALIA - Via P. Bettini, 19 Z. I. Tel. (+39).0442.659028 - Telefax (+39).0442.659045
E-mail : info@fiammagiro.it - fiammaVR@fiammagiro.it - ufficiotecnico@fiammagiro.it

<http://www.fiammagiro.com>

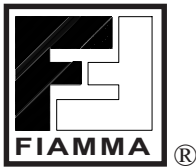

FIAMMA
GAS & ELECTRIC BOILER



**DECLARATION OF
CONFORMITY**

**UK
CA**

**DICHIARAZIONE DI
CONFORMITA'**

According to - *In accordo con :*

Electrical Equipment (Safety) Regulations 2016. - *Regolamento Apparecchiature Elettriche (Sicurezza) 2016.*

Electromagnetic Compatibility Regulations 2016. - *Regolamento Compatibilità Elettromagnetica 2016.*

The Restriction of the Use of Certain Hazardous Substances in Electrical and Electronic Equipment Regulations 2012.

Restrizioni all'Uso di Certe Sostanze Pericolose in Apparecchiature Elettriche ed Elettroniche 2012.

Identification No. - <i>N° di identificazione :</i>	See the serial number / Vedi numero di matricola.
Manufacturer - <i>Costruttore :</i>	FIAMMA GIRO s.r.l.
Address - <i>Indirizzo :</i>	via L. Landucci n°.2/B - 51100 PISTOIA - ITALY
Telephone - <i>Telefono :</i>	(+39).0573.532812
Telefax / E-mail - <i>Fax / e-mail :</i>	(+39).0573.532890 - info@fiammagiro.it
Type of equipment - <i>Tipo di apparecchio :</i>	Electric wall boiler / <i>Caldaia murale elettrica</i>
Trademark - <i>Marchio commerciale :</i>	 (marked FIAMMA / FIAMMA dicitura)
Type / Model - <i>Tipo / Modello :</i>	See the model in data code / <i>Vedi Modello su targhetta dati</i> ELEKTRA.. 6 ÷ 24 ... ELEKTRA.. 6 ÷ 24...

The following standards or technical specifications (designations) which comply with good engineering practice in safety matters in force have been applied :

Le norme o le specifiche tecniche (designazioni) che sono state applicate in accordo con le regole della buona arte in materia di sicurezza sono :

Standards or other normative document - *Norme o altri documenti normativi*

IEC 60335-1:2010+A1:2013+A2:2016 – IEC 60335-2-21:2012+A1:2018

EN 60335-2-21:2003+A1:2005+A2:2008

EN 60335-1:2012+A11:2014+A13:2017+A1:2019+A2:2019+A14:2019

The boilers of the ELEKTRA.. series are CB certified with document number IT-22669/A1.

Le caldaie della serie ELEKTRA.. sono certificate CB con documento °.IT-22669/A1.

Test report-Technical file

Rapporto di collaudo - Schede tecniche

Nr. EP20-0059463-01 rev.1

EN 61000-3-11:2011; EN 61000-3-12:2011; EN 61000-3-11:2001; EN 61000-3-11:2000; EN 55014-1; EN 55014-2

The boilers of the ELEKTRA series have been verified with Test-Report n°. TRA-030968-36-00A.

Le caldaie della serie ELEKTRA sono state verificate con Test-Report n°.TRA-030968-36-00A



As the manufacturer's authorized, we declare under our sole responsibility that the equipment follows the provisions of the Regulations stated above.

In qualità di costruttore e/o rappresentante autorizzato della società, si dichiara sotto la propria responsabilità che gli apparecchi sono conformi alle esigenze essenziali previste da i Regolamenti su menzionati.

Pistoia, 15/07/2022

Giro Luca

Board Chairman of administration
presidente consiglio di amministrazione



SEDE: 51100 PISTOIA - ITALIA - Via L. Landucci, 2 z. i. - Tel. (+39).0573.532812 - Telefax: (+39).0573.532890. E-mail: fiammaPT@fiammagiro.it
Cap. soc. Euro.40.000,00 Int.versato. - P.I.V.A. 01432870473 - R.E.A. 149197 - Albo Art. PT49948
FILIALE: 37049 VILLA BARTOLOMEA (VR) - ITALIA - Via P. Bettini, 19 Z. I. Tel. (+39).0442.659028 - Telefax (+39).0442.659045
E-mail : info@fiammagiro.it - fiammaVR@fiammagiro.it - ufficiotecnico@fiammagiro.it
<http://www.fiammagiro.com>

official distributor for the United Kingdom (GB)



ABCOT UK Ltd.

Green Acres – Oakley Green Road – WINDSOR BERKSHIRE SL4 4QF.
Tel. 01628.636099 – 01628.676900 – Fax. 01628.676958 – E-mail: contact@electriccombi boilers.uk
www.electriccombi boilerscompany.com

ELECTRIC 
COMBI BOILERS CO.

Fiamma

FIAMMA GIRO s.r.l. Company group



Sede legale e stabilimento: via L. Landucci n° 2/B - 51100 PISTOIA - ITALY
Tel. (+39).0573.532812 Fax. (+39).0573.532890 - E.mail: fiammaPT@fiammagiro.it
Filiale e stabilimento: via P. Bettini n° 19 - 37049 VILLA BARTOLOMEA (VR) - ITALY
Tel. (+39).0442.659028 Fax. (+39).0442.659045 - E-mail: fiammaVR@fiammagiro.it

www.fiammagiro.com

Code M0114